



⚠ Read this manual carefully before operating this vehicle.

OWNER'S MANUAL



**MTM155**

B1V-F8199-E0 ●

 **Read this manual carefully before operating this vehicle. This manual should stay with this vehicle if it is sold.**

Welcome to the Yamaha world of motorcycling!

As the owner of the MTM155, you are benefiting from Yamaha's vast experience and newest technology regarding the design and manufacture of high-quality products, which have earned Yamaha a reputation for dependability.

Please take the time to read this manual thoroughly, so as to enjoy all advantages of your MTM155. The Owner's Manual does not only instruct you in how to operate, inspect and maintain your motorcycle, but also in how to safeguard yourself and others from trouble and injury.

In addition, the many tips given in this manual will help keep your motorcycle in the best possible condition. If you have any further questions, do not hesitate to contact your Yamaha dealer.

The Yamaha team wishes you many safe and pleasant rides. So, remember to put safety first!

Yamaha continually seeks advancements in product design and quality. Therefore, while this manual contains the most current product information available at the time of printing, there may be minor discrepancies between your motorcycle and this manual. If there is any question concerning this manual, please consult a Yamaha dealer.

---

** WARNING**

**Please read this manual carefully and completely before operating this motorcycle.**



---

# Important manual information

---

EAU10134

Particularly important information is distinguished in this manual by the following notations:

	<b>This is the safety alert symbol. It is used to alert you to potential personal injury hazards. Obey all safety messages that follow this symbol to avoid possible injury or death.</b>
	<b>A WARNING indicates a hazardous situation which, if not avoided, could result in death or serious injury.</b>
	<b>A NOTICE indicates special precautions that must be taken to avoid damage to the vehicle or other property.</b>
<b>TIP</b>	A TIP provides key information to make procedures easier or clearer.

\*Product and specifications are subject to change without notice.

EAU37432

**MTM155  
OWNER'S MANUAL  
©2020 by Thai Yamaha Motor Co., Ltd.  
1st edition, July 2019  
All rights reserved.  
Any reprinting or unauthorized use  
without the written permission of  
Thai Yamaha Motor Co., Ltd.  
is expressly prohibited.  
Printed in Thailand.**

# Table of contents

---

<b>Location of important labels</b> .....	1-1	<b>For your safety – pre-operation checks</b> .....	5-1	Adjusting the throttle grip free play .....	7-16
<b>Safety information</b> .....	2-1	<b>Operation and important riding points</b> .....	6-1	Valve clearance.....	7-16
Further safe-riding points .....	2-5	Engine break-in.....	6-1	Tires.....	7-17
Helmets .....	2-6	Starting the engine.....	6-2	Cast wheels .....	7-18
<b>Description</b> .....	3-1	Shifting .....	6-3	Adjusting the clutch lever free play .....	7-19
Left view .....	3-1	Tips for reducing fuel consumption.....	6-3	Checking the brake lever free play .....	7-20
Right view .....	3-2	Parking .....	6-4	Brake light switches .....	7-20
Controls and instruments .....	3-3	<b>Periodic maintenance and adjustment</b> .....	7-1	Checking the front and rear brake pads .....	7-21
<b>Instrument and control functions</b> .....	4-1	Tool kit .....	7-1	Checking the brake fluid level .....	7-22
Main switch/steering lock.....	4-1	Periodic maintenance chart for the emission control system.....	7-2	Changing the brake fluid .....	7-23
Keyhole shutter .....	4-2	General maintenance and lubrication chart.....	7-4	Drive chain slack.....	7-23
Indicator lights and warning lights.....	4-3	Removing and installing cowlings.....	7-8	Cleaning and lubricating the drive chain.....	7-25
Multi-function meter unit .....	4-4	Checking the spark plug.....	7-8	Checking and lubricating the cables.....	7-25
Multi-function display .....	4-6	Canister.....	7-10	Checking and lubricating the throttle grip and cable end.....	7-26
Handlebar switches.....	4-9	Engine oil and oil filter element .....	7-10	Checking and lubricating the brake and shift pedals.....	7-26
Clutch lever .....	4-10	Why Yamalube .....	7-13	Checking and lubricating the brake and clutch levers .....	7-27
Shift pedal .....	4-10	Coolant.....	7-13	Checking and lubricating the the sidestand.....	7-27
Brake lever.....	4-11	Air filter element and check hose .....	7-14	Lubricating the swingarm pivots.....	7-28
Brake pedal .....	4-11	Adjusting the engine idling speed .....	7-15	Checking the front fork.....	7-28
Fuel tank cap.....	4-11			Checking the steering.....	7-29
Fuel.....	4-12				
Catalytic converter .....	4-13				
Seat .....	4-14				
Helmet holder .....	4-14				
Sidestand .....	4-15				
Starting circuit cut-off system .....	4-15				

# Table of contents

---

- Checking the wheel bearings .....7-29
- Battery .....7-29
- Replacing the fuses.....7-31
- Vehicle lights .....7-31
- Replacing a turn signal  
light bulb .....7-32
- Supporting the motorcycle.....7-32
- Front wheel.....7-33
- Rear wheel.....7-34
- Troubleshooting .....7-35
- Troubleshooting chart .....7-36
  
- Motorcycle care and storage .....8-1**
  - Matte color caution .....8-1
  - Care.....8-1
  - Storage.....8-3
  
- Specifications.....9-1**
  
- Consumer information .....10-1**
  - Identification numbers.....10-1
  - Vehicle data recording .....10-2
  
- Index .....11-1**

# Location of important labels

EAU10385

1

Read and understand all of the labels on your vehicle. They contain important information for safe and proper operation of your vehicle. Never remove any labels from your vehicle. If a label becomes difficult to read or comes off, a replacement label is available from your Yamaha dealer.

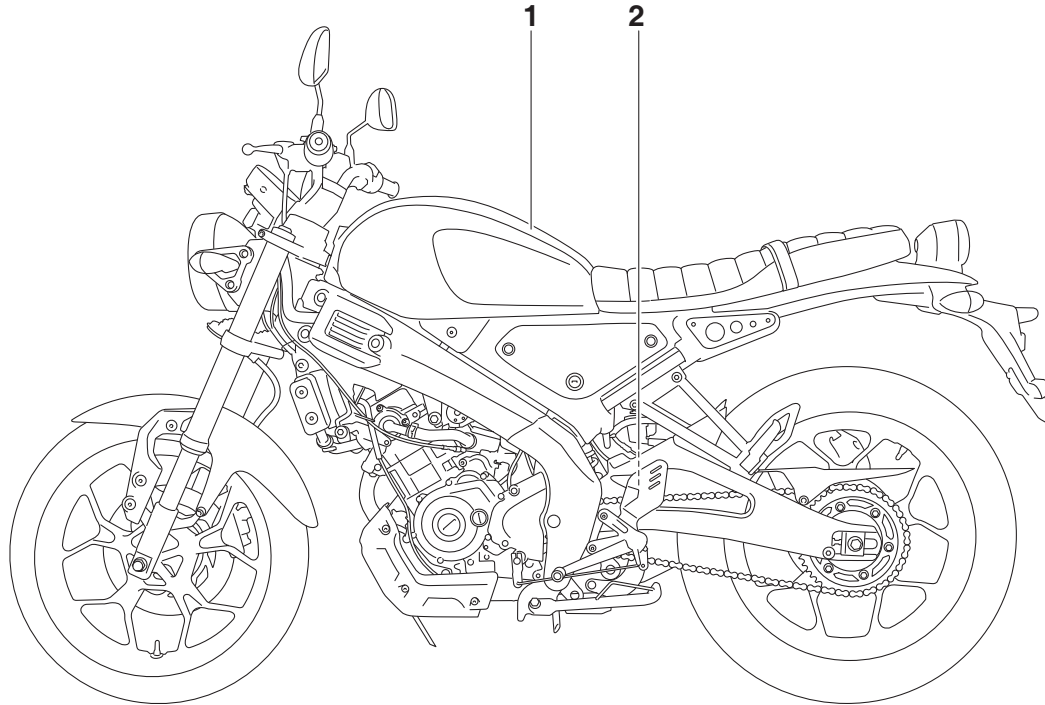



1



2

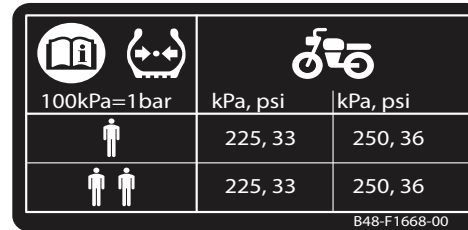

## Be a Responsible Owner

As the vehicle's owner, you are responsible for the safe and proper operation of your motorcycle.

Motorcycles are single-track vehicles. Their safe use and operation are dependent upon the use of proper riding techniques as well as the expertise of the operator. Every operator should know the following requirements before riding this motorcycle.

He or she should:

- Obtain thorough instructions from a competent source on all aspects of motorcycle operation.
- Observe the warnings and maintenance requirements in this Owner's Manual.
- Obtain qualified training in safe and proper riding techniques.
- Obtain professional technical service as indicated in this Owner's Manual and/or when made necessary by mechanical conditions.

- Never operate a motorcycle without proper training or instruction. Take a training course. Beginners should receive training from a certified instructor. Contact an authorized motorcycle dealer to find out about the training courses nearest you.

## Safe Riding

Perform the pre-operation checks each time you use the vehicle to make sure it is in safe operating condition. Failure to inspect or maintain the vehicle properly increases the possibility of an accident or equipment damage. See page 5-1 for a list of pre-operation checks.

- This motorcycle is designed to carry the operator and a passenger.
- The failure of motorists to detect and recognize motorcycles in traffic is the predominating cause of automobile/motorcycle accidents. Many accidents have been caused by an automobile driver who did not see the motorcycle. Making yourself conspicuous ap-

pears to be very effective in reducing the chance of this type of accident.

### Therefore:

- Wear a brightly colored jacket.
- Use extra caution when you are approaching and passing through intersections, since intersections are the most likely places for motorcycle accidents to occur.
- Ride where other motorists can see you. Avoid riding in another motorist's blind spot.
- Never maintain a motorcycle without proper knowledge. Contact an authorized motorcycle dealer to inform you on basic motorcycle maintenance. Certain maintenance can only be carried out by certified staff.

- Many accidents involve inexperienced operators. In fact, many operators who have been involved in accidents do not even have a current motorcycle license.
  - Make sure that you are qualified and that you only lend your motorcycle to other qualified operators.
  - Know your skills and limits. Staying within your limits may help you to avoid an accident.
  - We recommend that you practice riding your motorcycle where there is no traffic until you have become thoroughly familiar with the motorcycle and all of its controls.
- Many accidents have been caused by error of the motorcycle operator. A typical error made by the operator is veering wide on a turn due to excessive speed or undercornering (insufficient lean angle for the speed).
  - Always obey the speed limit and never travel faster than warranted by road and traffic conditions.
  - Always signal before turning or changing lanes. Make sure that other motorists can see you.
- The posture of the operator and passenger is important for proper control.
  - The operator should keep both hands on the handlebar and both feet on the operator footrests during operation to maintain control of the motorcycle.
  - The passenger should always hold onto the operator, the seat strap or grab bar, if equipped, with both hands and keep both feet on the passenger footrests. Never carry a passenger unless he or she can firmly place both feet on the passenger footrests.
- Never ride under the influence of alcohol or other drugs.
- This motorcycle is designed for on-road use only. It is not suitable for off-road use.

### **Protective Apparel**

The majority of fatalities from motorcycle accidents are the result of head injuries. The use of a safety helmet is the single most critical factor in the prevention or reduction of head injuries.

- Always wear an approved helmet.
- Wear a face shield or goggles. Wind in your unprotected eyes could contribute to an impairment of vision that could delay seeing a hazard.
- The use of a jacket, heavy boots, trousers, gloves, etc., is effective in preventing or reducing abrasions or lacerations.
- Never wear loose-fitting clothes, otherwise they could catch on the control levers, footrests, or wheels and cause injury or an accident.
- Always wear protective clothing that covers your legs, ankles, and feet. The engine or exhaust system become very hot during or after operation and can cause burns.
- A passenger should also observe the above precautions.

## Safety information

2

### **Avoid Carbon Monoxide Poisoning**

All engine exhaust contains carbon monoxide, a deadly gas. Breathing carbon monoxide can cause headaches, dizziness, drowsiness, nausea, confusion, and eventually death.

Carbon Monoxide is a colorless, odorless, tasteless gas which may be present even if you do not see or smell any engine exhaust. Deadly levels of carbon monoxide can collect rapidly and you can quickly be overcome and unable to save yourself. Also, deadly levels of carbon monoxide can linger for hours or days in enclosed or poorly ventilated areas. If you experience any symptoms of carbon monoxide poisoning, leave the area immediately, get fresh air, and **SEEK MEDICAL TREATMENT.**

- Do not run engine indoors. Even if you try to ventilate engine exhaust with fans or open windows and doors, carbon monoxide can rapidly reach dangerous levels.
- Do not run engine in poorly ventilated or partially enclosed areas such as barns, garages, or carports.

- Do not run engine outdoors where engine exhaust can be drawn into a building through openings such as windows and doors.

### **Loading**

Adding accessories or cargo to your motorcycle can adversely affect stability and handling if the weight distribution of the motorcycle is changed. To avoid the possibility of an accident, use extreme caution when adding cargo or accessories to your motorcycle. Use extra care when riding a motorcycle that has added cargo or accessories. Here, along with the information about accessories below, are some general guidelines to follow if loading cargo to your motorcycle:

The total weight of the operator, passenger, accessories and cargo must not exceed the maximum load limit.

**Operation of an overloaded vehicle could cause an accident.**

**Maximum load:**  
172 kg (379 lb)

When loading within this weight limit, keep the following in mind:

- Cargo and accessory weight should be kept as low and close to the motorcycle as possible. Securely pack your heaviest items as close to the center of the vehicle as possible and make sure to distribute the weight as evenly as possible on both sides of the motorcycle to minimize imbalance or instability.
- Shifting weights can create a sudden imbalance. Make sure that accessories and cargo are securely attached to the motorcycle before riding. Check accessory mounts and cargo restraints frequently.
- Properly adjust the suspension for your load (suspension-adjustable models only), and check the condition and pressure of your tires.
- Never attach any large or heavy items to the handlebar, front fork, or front fender. These items, including such cargo as sleeping bags, duffel bags, or

tents, can create unstable handling or a slow steering response.

- **This vehicle is not designed to pull a trailer or to be attached to a sidecar.**

### **Genuine Yamaha Accessories**

Choosing accessories for your vehicle is an important decision. Genuine Yamaha accessories, which are available only from a Yamaha dealer, have been designed, tested, and approved by Yamaha for use on your vehicle.

Many companies with no connection to Yamaha manufacture parts and accessories or offer other modifications for Yamaha vehicles. Yamaha is not in a position to test the products that these aftermarket companies produce. Therefore, Yamaha can neither endorse nor recommend the use of accessories not sold by Yamaha or modifications not specifically recommended by Yamaha, even if sold and installed by a Yamaha dealer.

### **Aftermarket Parts, Accessories, and Modifications**

While you may find aftermarket products similar in design and quality to genuine Yamaha accessories, recognize that some aftermarket accessories or modifications are not suitable because of potential safety hazards to you or others. Installing aftermarket products or having other modifications performed to your vehicle that change any of the vehicle's design or operation characteristics can put you and others at greater risk of serious injury or death. You are responsible for injuries related to changes in the vehicle.

Keep the following guidelines in mind, as well as those provided under "Loading" when mounting accessories.

- Never install accessories or carry cargo that would impair the performance of your motorcycle. Carefully inspect the accessory before using it to make sure that it does not in any way reduce ground clearance or cornering clearance, limit suspension travel,

steering travel or control operation, or obscure lights or reflectors.

- Accessories fitted to the handlebar or the front fork area can create instability due to improper weight distribution or aerodynamic changes. If accessories are added to the handlebar or front fork area, they must be as lightweight as possible and should be kept to a minimum.
- Bulky or large accessories may seriously affect the stability of the motorcycle due to aerodynamic effects. Wind may attempt to lift the motorcycle, or the motorcycle may become unstable in cross winds. These accessories may also cause instability when passing or being passed by large vehicles.
- Certain accessories can displace the operator from his or her normal riding position. This improper position limits the freedom of movement of the

## Safety information

2

operator and may limit control ability, therefore, such accessories are not recommended.

- Use caution when adding electrical accessories. If electrical accessories exceed the capacity of the motorcycle's electrical system, an electric failure could result, which could cause a dangerous loss of lights or engine power.

### Aftermarket Tires and Rims

The tires and rims that came with your motorcycle were designed to match the performance capabilities and to provide the best combination of handling, braking, and comfort. Other tires, rims, sizes, and combinations may not be appropriate. See page 7-17 for tire specifications and for information on servicing and replacing your tires.

### Transporting the Motorcycle

Be sure to observe following instructions before transporting the motorcycle in another vehicle.

- Remove all loose items from the motorcycle.
- Check that the fuel cock (if equipped) is in the off position and that there are no fuel leaks.
- Shift the transmission into gear (for models with a manual transmission).
- Secure the motorcycle with tie-downs or suitable straps that are attached to solid parts of the motorcycle, such as the frame or upper front fork triple clamp (and not, for example, to rubber-mounted handlebars or turn signals, or parts that could break). Choose the location for the straps carefully so the straps will not rub against painted surfaces during transport.
- The suspension should be compressed somewhat by the tie-downs, if possible, so that the motorcycle will not bounce excessively during transport.

### Further safe-riding points

EAU57610

- Be sure to signal clearly when making turns.
- Braking can be extremely difficult on a wet road. Avoid hard braking, because the motorcycle could slide. Apply the brakes slowly when stopping on a wet surface.
- Slow down as you approach a corner or turn. Once you have completed a turn, accelerate slowly.
- Be careful when passing parked cars. A driver might not see you and open a door in your path.
- Railroad crossings, streetcar rails, iron plates on road construction sites, and manhole covers become extremely slippery when wet. Slow down and cross them with caution. Keep the motorcycle upright, otherwise it could slide out from under you.
- The brake pads or linings could get wet when you wash the motorcycle. After washing the motorcycle, check the brakes before riding.

- Always wear a helmet, gloves, trousers (tapered around the cuff and ankle so they do not flap), and a brightly colored jacket.
- Do not carry too much luggage on the motorcycle. An overloaded motorcycle is unstable. Use a strong cord to secure any luggage to the carrier (if equipped). A loose load will affect the stability of the motorcycle and could divert your attention from the road. (See page 2-3.)

## Helmet

EAUU0033

Operating this vehicle without an approved motorcycle helmet increases your chances of a severe head injury or death in the event of an accident. The majority of fatalities from motorcycle or scooter accidents are the result of head injuries. The use of a safety helmet is the single most critical factor in the prevention or reduction of head injuries.

### Always select an approved motorcycle helmet

Pay attention to the following when choosing a motorcycle helmet.

- The helmet must meet the safety standard “TIS”.
- The helmet size must match the size of the rider’s head.
- Never subject a helmet to heavy shocks.

### Wearing the helmet correctly

Always connect the chin strap. In the case of an accident, the helmet has a much less chance of coming off if the chin strap is connected.

### Correct usage



ZAUU0003

### Wrong usage



ZAUU0007

### Types of helmets and their usage

- Half-type: use only for riding at low speeds
- Full-type: use only for riding at low to mid-range speeds

# Safety information

---

2



ZAUU0005

- Full-face-type: use for riding at mid-range to high speeds



ZAUU0006



## Left view

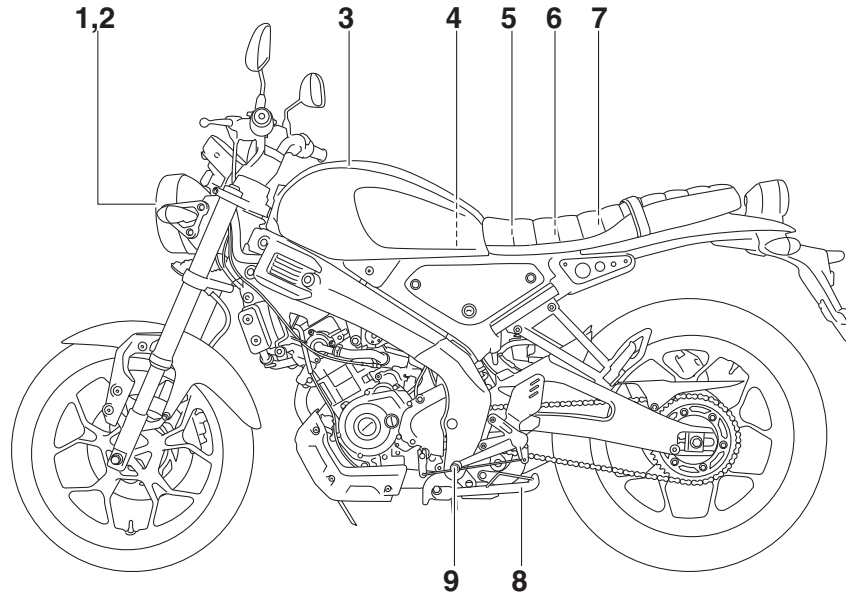

- 1. Headlight (page 7-31)
- 2. Auxiliary light
- 3. Fuel tank cap (page 4-11)
- 4. Air filter (page 7-14)
- 5. Battery (page 7-29)
- 6. Fuse (page 7-31)
- 7. Owner's tool kit (page 7-1)
- 8. Sidestand (page 4-15)

- 9. Shift pedal (page 4-10)

# Description

EAU10421

## Right view

3

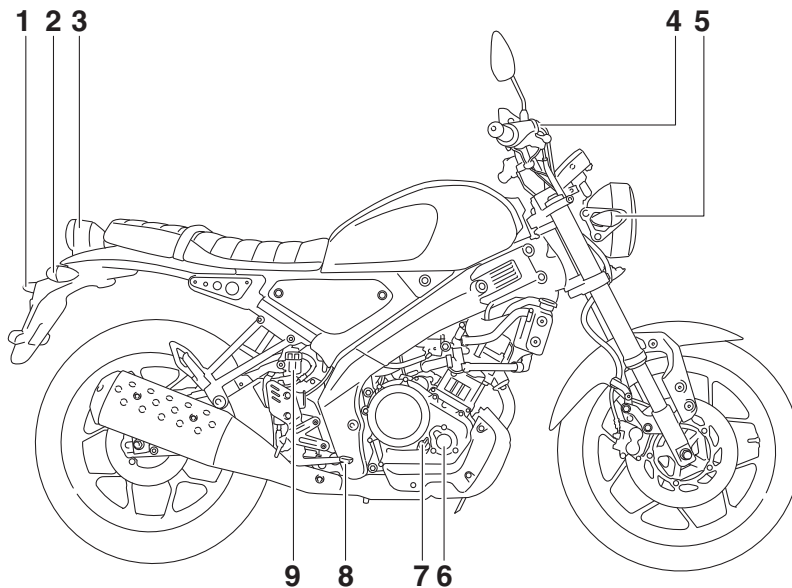

1. License plate light
2. Rear turn signal light (page 7-32)
3. Tail/brake light
4. Front brake fluid reservoir (page 7-22)
5. Front turn signal light (page 7-32)
6. Engine oil filter element (page 7-10)
7. Dipstick (page 7-10)
8. Brake pedal (page 4-11)

9. Rear brake fluid reservoir (page 7-22)

## Controls and instruments

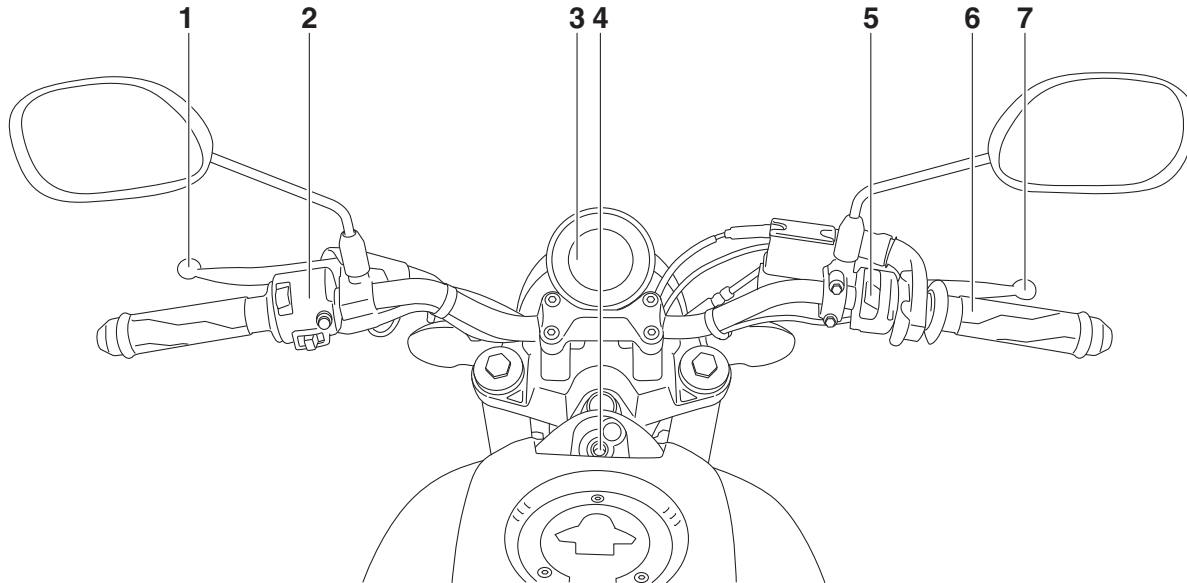

1. Clutch lever (page 4-10)
2. Left handlebar switches (page 4-9)
3. Multi-function meter unit (page 4-4)
4. Main switch/steering lock (page 4-1)
5. Right handlebar switches (page 4-9)
6. Throttle grip (page 7-16)
7. Brake lever (page 4-11)

# Instrument and control functions

4

## Main switch/steering lock

EAUN0264

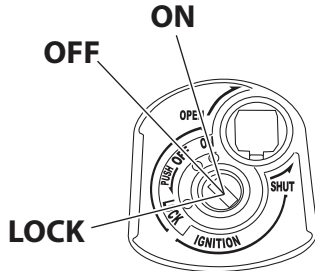

The main switch/steering lock controls the ignition and lighting systems, and is used to lock the steering. The various main switch positions are described below.

### TIP

The main switch/steering lock is equipped with a keyhole shutter. (See page 4-2 for keyhole shutter opening and closing procedures.)

### ON

EAU85030

All electrical circuits are supplied with power and the vehicle lights are turned on. The engine can be started. The key cannot be removed.

### TIP

- To prevent battery discharge, do not leave the key in the on position without the engine running.
- This model is equipped with a fuel pump. When the vehicle is first turned on, a noise from the fuel pump can be heard, but this is not a malfunction.

### OFF

EAU10662

All electrical systems are off. The key can be removed.

### **WARNING**

EWA10062

**Never turn the key to “OFF” or “LOCK” while the vehicle is moving. Otherwise the electrical systems will be switched off, which may result in loss of control or an accident.**

### LOCK

EAUP0052

The steering is locked and all electrical systems are off. The key can be removed.

## To lock the steering

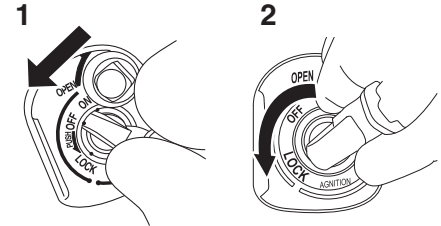

1. Push.
2. Turn.

1. Turn the handlebars all the way to the left or right.
2. With the key in the “OFF” position, push the key in and turn it to “LOCK”.
3. Remove the key.

### TIP

If the steering will not lock, try turning the handlebars slightly back to the right or left.

# Instrument and control functions

## To unlock the steering

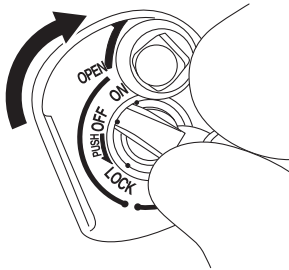

1. Insert the key at the “LOCK” position.
2. Turn the key to “OFF”.

## Keyhole shutter

EAU61101

## To close the keyhole shutter

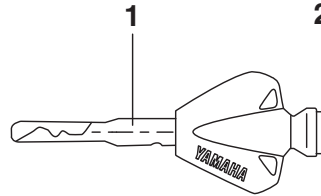

1. Main switch/steering lock key
2. Keyhole shutter key

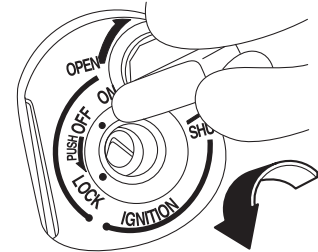

Insert the keyhole shutter key into the keyhole shutter receptacle as shown, and then turn the key to the left to close the keyhole shutter.

## To open the keyhole shutter

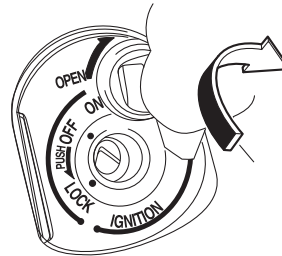





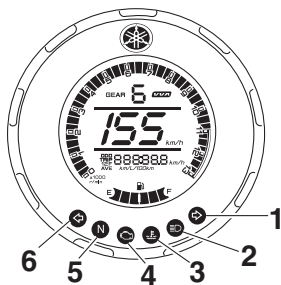

Insert the keyhole shutter key into the keyhole shutter receptacle as shown, and then turn the key to the right to open the keyhole shutter.

# Instrument and control functions

## Indicator lights and warning lights

EAU4939H



1. Right turn signal indicator light “”
2. High beam indicator light “”
3. Coolant temperature warning light “”
4. Engine trouble warning light “”
5. Neutral indicator light “**N**”
6. Left turn signal indicator light “”

## Turn signal indicator lights “” and “”

EAU11032

Each indicator light will flash when its corresponding turn signal lights are flashing.

## Neutral indicator light “**N**”

EAU11061

This indicator light comes on when the transmission is in the neutral position.

## High beam indicator light “”

EAU11081

This indicator light comes on when the high beam of the headlight is switched on.

## Coolant temperature warning light “”

EAU11449

This warning light comes on when the engine is overheating. If this occurs, stop the engine immediately and allow the engine to cool. (See page 7-37.)

For vehicles with a radiator fan, the radiator fan(s) automatically switch on or off according to the coolant temperature.

## TIP

When the vehicle is turned on, the light will come on for a few seconds, and then go off. If the light does not come on, or if the light remains on, have a Yamaha dealer check the vehicle.

ECA10022

## NOTICE

**Do not continue to operate the engine if it is overheating.**

## Engine trouble warning light “”

EAU73172

This warning light comes on if a problem is detected in the engine or other vehicle control system. If this occurs, have a Yamaha dealer check the on-board diagnostic system.

## TIP

When the vehicle is turned on, the light will come on for a few seconds and then go off. If the light does not come on, or if the light remains on, have a Yamaha dealer check the vehicle.

## Multi-function meter unit

EAU87110

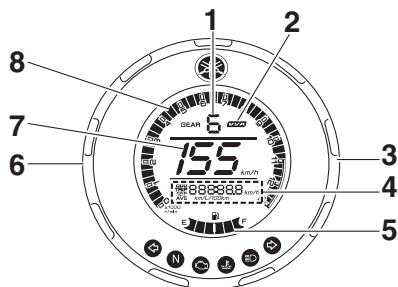

1. Transmission gear display
2. VVA (variable valve actuation) indicator
3. "RESET" button
4. Multi-function display
5. Fuel meter
6. "SELECT" button
7. Speedometer
8. Tachometer

The multi-function meter unit is also equipped with a backlight setting mode.

EWA12423



**WARNING**

Be sure to stop the vehicle before making any setting changes to the multi-function meter unit. Changing

settings while riding can distract the operator and increase the risk of an accident.

## Speedometer

EAU86831

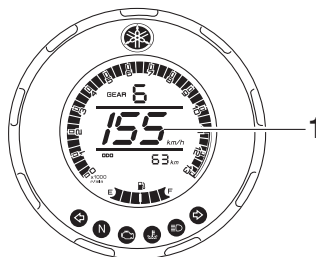

1. Speedometer

The speedometer shows the vehicle's traveling speed.

## Tachometer

EAU87170

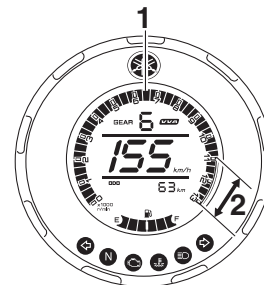

1. Tachometer
2. Red zone

The tachometer allows the rider to monitor the engine speed and keep it within the ideal power range.

ECA10032

## **NOTICE**

**Do not operate the engine in the tachometer red zone.**

**Red zone: 11000 r/min and above**

# Instrument and control functions

## Fuel meter

EAU86841

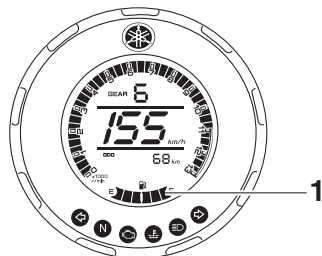

### 1. Fuel meter

The fuel meter indicates the amount of fuel in the fuel tank. The display segments of the fuel meter disappear from “F” (full) towards “E” (empty) as the fuel level decreases. When approximately 1.8 L (0.48 US gal, 0.40 Imp.gal) of fuel remains, the last segment starts flashing. Refuel as soon as possible.

### TIP

If a problem is detected in the electrical circuit, the fuel level segments will flash repeatedly. If this occurs, have a Yamaha dealer check the vehicle.

## VVA indicator

EAU87370

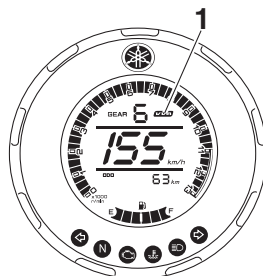

### 1. VVA (variable valve actuation) indicator

This model is equipped with variable valve actuation (VVA) for good fuel economy and acceleration in both the low-speed and high-speed ranges. The VVA indicator comes on when the variable valve actuation system has switched to the high-speed range.

## Transmission gear display

EAU87390

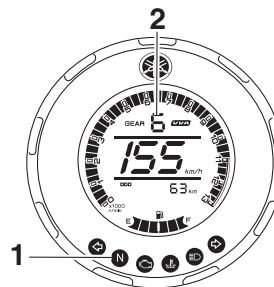

1. Neutral indicator light “N”
2. Transmission gear display

This display shows the selected gear. The neutral position is indicated by “-” and by the neutral indicator light.



## Multi-function display

EAUJ2211

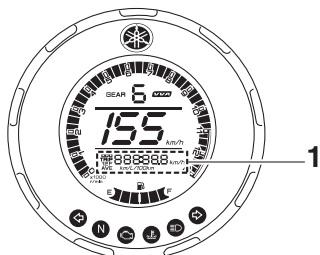

1. Multi-function display

The multi-function display is equipped with the following:

- an odometer (ODO)
- two tripmeters (TRIP 1 and TRIP 2)
- a fuel reserve tripmeter (TRIP F)
- a clock
- an instantaneous fuel consumption display (km/L or L/100 km)
- an average fuel consumption display (AVE\_ \_ km/L or AVE\_ \_ L/100 km)
- an average speed display (AVE\_ \_ km/h)
- a backlight display (bL-01, bL-02 or bL-03)

Push the “SELECT” button to change the display in the following order:

ODO → TRIP 1 → TRIP 2 → TRIP F → clock → km/L or L/100 km → AVE\_ \_ km/L or AVE\_ \_ L/100 km → AVE\_ \_ km/h → backlight (bL-01, bL-02 or bL-03) → ODO

### TIP

- The fuel reserve tripmeter appears only when you are low on fuel.
- Push the “RESET” button to change the display in the reverse order.

## Odometer

EAU86890

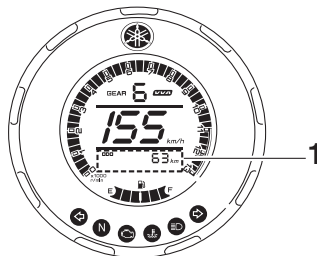

1. Odometer

The odometer shows the total distance traveled by the vehicle.

### TIP

The odometer will lock at 999999 and cannot be reset.

EAU88050

## Tripmeters

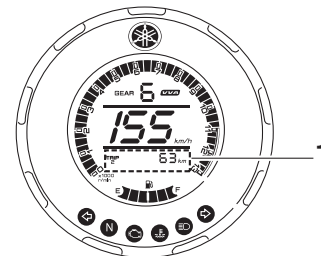

1. Tripmeter

The tripmeters show the distance traveled since they were last reset.

To reset a tripmeter, change the display to the tripmeter you want to reset, and then push the “RESET” button until it is reset.

### TIP

The tripmeters will reset and continue counting after 9999.9 is reached.

# Instrument and control functions

## Fuel reserve tripmeter

EAU87600

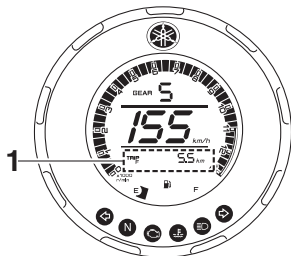

1. Fuel reserve tripmeter

If the last segment of the fuel meter starts flashing, the display automatically changes to the fuel reserve tripmeter “TRIP F” and starts counting the distance traveled from that point.

To reset the fuel reserve tripmeter, push the “RESET” button until it is reset.

### TIP

If you do not reset the fuel reserve tripmeter manually, it will reset automatically and disappear from the display after refueling and traveling 5 km (3 mi).

## Clock

EAU87600

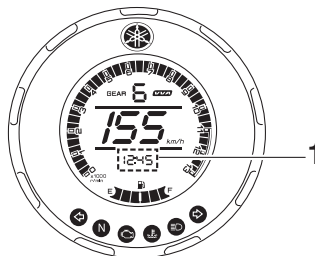

1. Clock

The clock uses a 12-hour time system.

### To set the clock

1. Push the “SELECT” button to change the display to the clock.
2. Push the “SELECT” button until the hour digits start flashing.
3. Use the “RESET” button to set the hours.
4. Push the “SELECT” button and the minute digits start flashing.
5. Use the “RESET” button to set the minutes.
6. Push the “SELECT” button to confirm the settings.

## Instantaneous fuel consumption display

EAU87740

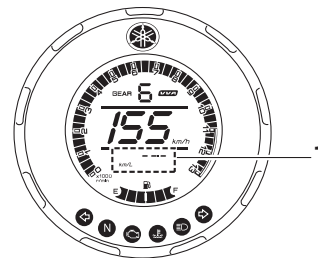

1. Instantaneous fuel consumption display

This display shows the fuel consumption under the current riding conditions. It can be set to either “km/L” or “L/100 km”. To switch the fuel consumption measurement units, push the “SELECT” button until the measurement units change.

- “km/L”: the distance that can be traveled on 1.0 L of fuel.
- “L/100 km”: the amount of fuel necessary to travel 100 km.

### TIP

When traveling under 10 km/h (6 mi/h), “\_ \_ \_” is displayed.

EAU87850

## Average fuel consumption display

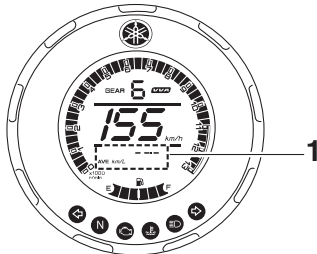

### 1. Average fuel consumption display

This display shows the average fuel consumption since it was last reset. The average fuel consumption display can be set to either “AVE\_ \_ km/L” or “AVE\_ \_ L/100 km”. To switch the fuel consumption measurement units, push the “SELECT” button until the measurement units change.

- “AVE\_ \_ km/L”: the average distance that can be traveled on 1.0 L of fuel.
- “AVE\_ \_ L/100 km”: the average amount of fuel necessary to travel 100 km.

## TIP \_\_\_\_\_

- To reset the display, push the “RESET” button until it resets.
- After resetting, “\_ \_” is shown until the vehicle has traveled some distance.

EAU87880

## Average speed display

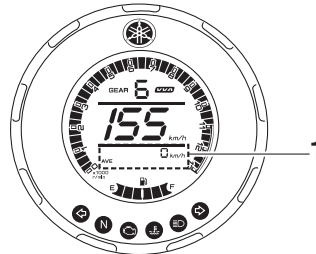

### 1. Average speed display

This display shows the vehicle’s average traveling speed since it was last reset.

To reset the average speed display, push the “RESET” button until it is reset.

EAUN2690

## Backlight setting mode

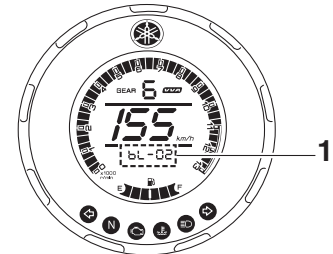

### 1. Backlight setting mode

This mode allows you to change the backlight setting.

## To enter the backlight setting mode

1. Stop the vehicle.
2. Push the “SELECT” button to change the multi-function display to show the current backlight setting “bL-01”, “bL-02”, or “bL-03”.
3. Push the “SELECT” button until the multi-function display enters the backlight setting mode.
4. Push the “RESET” button to select the desired backlight setting.

# Instrument and control functions

5. Push the “SELECT” button until the multi-function display exits the backlight setting mode.

## Handlebar switches

EAU1234M

### Left

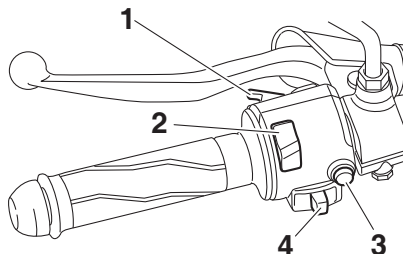

1. Pass switch “PASS”
2. Dimmer switch “ $\equiv$ ○/ $\equiv$ ○”
3. Horn switch “ $\text{H}$ ”
4. Turn signal switch “ $\leftarrow$ / $\rightarrow$ ”

### Right

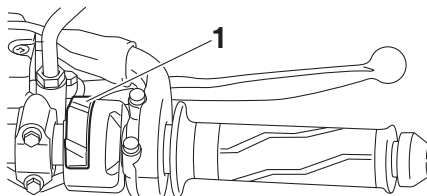

1. Start/Engine stop switch “ $\text{S}$ / $\text{O}$ / $\text{X}$ ”

## Dimmer/Pass switch “ $\equiv$ ○/ $\equiv$ ○/PASS”

EAU54202

Set this switch to “ $\equiv$ ○” for the high beam and to “ $\equiv$ ○” for the low beam. To flash the high beam, push the switch down towards “PASS” while the headlights are on low beam.

## Turn signal switch “ $\leftarrow$ / $\rightarrow$ ”

EAU12461

To signal a right-hand turn, push this switch to “ $\rightarrow$ ”. To signal a left-hand turn, push this switch to “ $\leftarrow$ ”. When released, the switch returns to the center position. To cancel the turn signal lights, push the switch in after it has returned to the center position.

## Horn switch “ $\text{H}$ ”

EAU12501

Press this switch to sound the horn.

## Start/Engine stop switch “ $\text{S}$ / $\text{O}$ / $\text{X}$ ”

EAU68270

To crank the engine with the starter, set this switch to “ $\text{O}$ ”, and then slide the switch toward “ $\text{S}$ ”. See page 6-2 for starting instructions prior to starting the engine.

Set this switch to “” to stop the engine in case of an emergency, such as when the vehicle overturns or when the throttle cable is stuck.

## Clutch lever

EAU31642

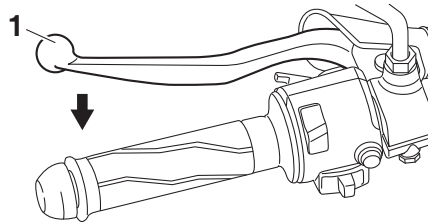

1. Clutch lever

The clutch lever is located on the left side of the handlebar. To disengage the clutch, pull the lever toward the handlebar grip. To engage the clutch, release the lever. The lever should be pulled rapidly and released slowly for smooth clutch operation.

The clutch lever is equipped with a clutch switch, which is part of the starting circuit cut-off system. (See page 4-15.)

## Shift pedal

EAU12876

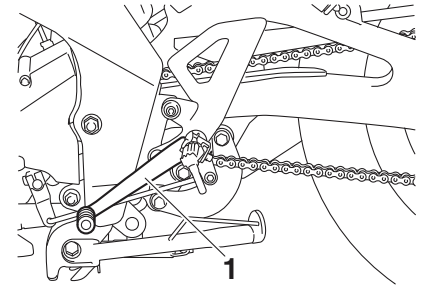

1. Shift pedal

The shift pedal is located on the left side of the motorcycle. To shift the transmission to a higher gear, move the shift pedal up. To shift the transmission to a lower gear, move the shift pedal down. (See page 6-3.)

# Instrument and control functions

## Brake lever

EAU12892

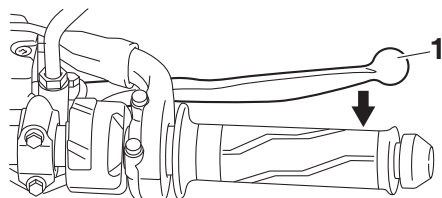

1. Brake lever

The brake lever is located on the right side of the handlebar. To apply the front brake, pull the lever toward the throttle grip.

## Brake pedal

EAU12944

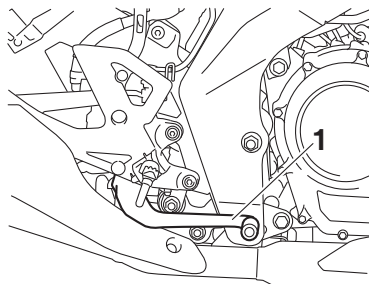

1. Brake pedal

The brake pedal is located on the right side of the motorcycle. To apply the rear brake, press down on the brake pedal.

## Fuel tank cap

EAUE1481

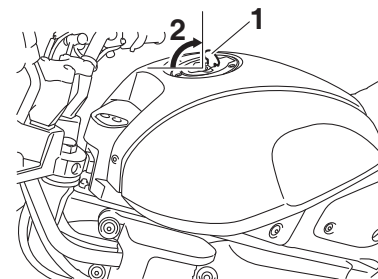

1. Fuel tank cap lock cover
2. Unlock.

### To remove the fuel tank cap

1. Open the fuel tank cap lock cover.
2. Insert the key into the lock and turn it 1/4 turn clockwise. The lock will be released and the fuel tank cap can be removed.

### To install the fuel tank cap

1. Push the fuel tank cap into position with the key inserted in the lock.
2. Turn the key counterclockwise to the original position, and then remove it.
3. Close the lock cover.

## TIP \_\_\_\_\_

The fuel tank cap cannot be installed unless the key is in the lock. In addition, the key cannot be removed if the cap is not properly installed and locked.

## WARNING \_\_\_\_\_

EWA11142

**Make sure that the fuel tank cap is properly installed before riding. Leaking fuel is a fire hazard.**

## Fuel

Make sure there is sufficient gasoline in the tank.

EAU13213

## WARNING \_\_\_\_\_

EWA10882

**Gasoline and gasoline vapors are extremely flammable. To avoid fires and explosions and to reduce the risk of injury when refueling, follow these instructions.**

1. Before refueling, turn off the engine and be sure that no one is sitting on the vehicle. Never refuel while smoking, or while in the vicinity of sparks, open flames, or other sources of ignition such as the pilot lights of water heaters and clothes dryers.
2. Do not overfill the fuel tank. Stop filling when the fuel reaches the bottom of the filler tube. Because fuel expands when it heats up, heat from the engine or the sun can cause fuel to spill out of the fuel tank.

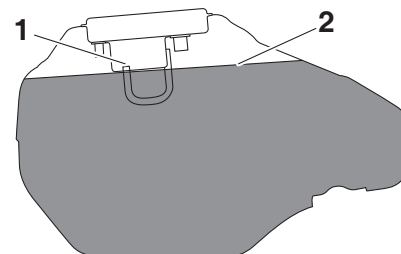

1. Fuel tank filler tube
2. Maximum fuel level
3. Wipe up any spilled fuel immediately. **NOTICE: Immediately wipe off spilled fuel with a clean, dry, soft cloth, since fuel may deteriorate painted surfaces or plastic parts.** [ECA10072]
4. Be sure to securely close the fuel tank cap.

## WARNING \_\_\_\_\_

EWA15152

**Gasoline is poisonous and can cause injury or death. Handle gasoline with care. Never siphon gasoline by mouth. If you should swallow some gasoline or inhale a lot of gasoline vapor, or get some gasoline in your eyes, see your doctor immedi-**

# Instrument and control functions

---

ately. If gasoline spills on your skin, wash with soap and water. If gasoline spills on your clothing, change your clothes.

---

EAUJ0045

recommended by Yamaha because it can cause damage to the fuel system or vehicle performance problems.

4

## Recommended fuel:

Regular unleaded gasoline (E10 acceptable)

## Fuel tank capacity:

10 L (2.6 US gal, 2.2 Imp.gal)

ECA11401

## NOTICE

---

Use only unleaded gasoline. The use of leaded gasoline will cause severe damage to internal engine parts, such as the valves and piston rings, as well as to the exhaust system.

---

## Gasohol

There are two types of gasohol: gasohol containing ethanol and that containing methanol. Gasohol containing ethanol can be used if the ethanol content does not exceed 10% (E10). Gasohol containing methanol is not

EAU13435

## Catalytic converter

The exhaust system contains catalytic converter(s) to reduce harmful exhaust emissions.

EWA10863

## WARNING

---

The exhaust system is hot after operation. To prevent a fire hazard or burns:

- Do not park the vehicle near possible fire hazards such as grass or other materials that easily burn.
  - Park the vehicle in a place where pedestrians or children are not likely to touch the hot exhaust system.
  - Make sure that the exhaust system has cooled down before doing any maintenance work.
  - Do not allow the engine to idle more than a few minutes. Long idling can cause a build-up of heat.
-



EAU13941

## Seat

### To remove the seat

1. Insert the key into the seat lock, and then turn it clockwise.

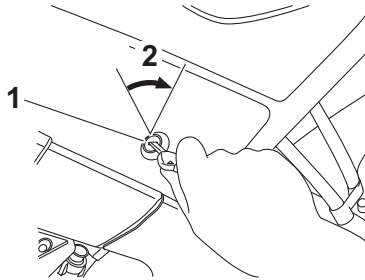

1. Seat lock
2. Turn.

2. While holding the key in that position, lift the rear of the seat, and then pull the seat off.

### To install the seat

1. Insert the projections on the front of the seat into the seat holder as shown.

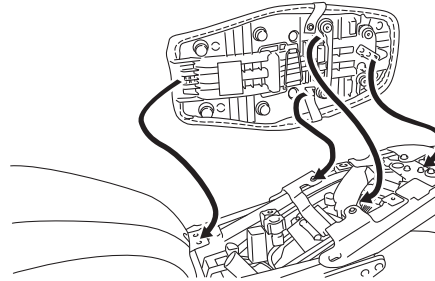

2. Push the rear of the seat down to lock it in place.
3. Remove the key.

### TIP

Make sure that the seat is properly secured before riding.

EAU14326

## Helmet holder

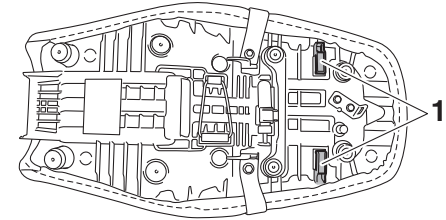

1. Helmet holder

The helmet holder is located under the rider seat.

### To secure a helmet to the helmet holder

1. Remove the rider seat.
2. Hook the helmet onto the helmet holder, and then securely install the seat. **WARNING! Never ride with a helmet attached to the helmet holder, since the helmet may hit objects, causing loss of control and possibly an accident.** [EWA10162]

# Instrument and control functions

---

## To release the helmet from the helmet holder

Remove the rider seat, remove the helmet from the helmet holder, and then install the seat.

## Sidestand

EAU37491

The sidestand is located on the left side of the frame. Raise the sidestand or lower it with your foot while holding the vehicle upright.

EWA14191



**The vehicle must not be ridden with the sidestand down, or if the sidestand cannot be properly moved up (or does not stay up), otherwise the sidestand could contact the ground and distract the operator, resulting in a possible loss of control.**

---

## Starting circuit cut-off system

EAU15397

This system prevents in-gear engine starts unless the clutch lever is pulled. Periodically check the system via the following procedure.

### TIP

- This check is most reliable if performed with a warmed-up engine.
  - See pages 4-1 and 4-9 for switch operation information.
-

# Instrument and control functions

With the engine turned off:  
1. Set engine stop switch to run position.  
2. Turn main switch to on position.  
3. Shift transmission into neutral.  
4. Push the start switch.  
**Does the engine start?**

YES

NO

5. Stop the engine.  
6. Set engine stop switch to run position.  
7. Shift transmission into gear.  
8. Pull the clutch lever.  
9. Push the start switch.  
**Does the engine start?**

YES

NO

The system is OK. **The motorcycle can be ridden.**



**WARNING**  
If a malfunction is found, have the vehicle inspected before riding.

The neutral switch may not be working.  
**The vehicle should not be ridden** until checked by a Yamaha dealer.

The clutch switch may not be working.  
**The vehicle should not be ridden** until checked by a Yamaha dealer.

# For your safety – pre-operation checks

EAU15599

Inspect your vehicle each time you use it to make sure the vehicle is in safe operating condition. Always follow the inspection and maintenance procedures and schedules described in the Owner's Manual.

EWA11152

## **WARNING**

**Failure to inspect or maintain the vehicle properly increases the possibility of an accident or equipment damage. Do not operate the vehicle if you find any problem. If a problem cannot be corrected by the procedures provided in this manual, have the vehicle inspected by a Yamaha dealer.**

Before using this vehicle, check the following points:

5

ITEM	CHECKS	PAGE
Fuel	<ul style="list-style-type: none"><li>• Check fuel level in fuel tank.</li><li>• Refuel if necessary.</li><li>• Check fuel line for leakage.</li><li>• Check fuel tank breather hose and overflow hose for obstructions, cracks or damage, and check hose connections.</li></ul>	4-12
Engine oil	<ul style="list-style-type: none"><li>• Check oil level in engine.</li><li>• If necessary, add recommended oil to specified level.</li><li>• Check vehicle for oil leakage.</li></ul>	7-10
Coolant	<ul style="list-style-type: none"><li>• Check coolant level in reservoir.</li><li>• If necessary, add recommended coolant to specified level.</li><li>• Check cooling system for leakage.</li></ul>	7-13
Front brake	<ul style="list-style-type: none"><li>• Check operation.</li><li>• If soft or spongy, have Yamaha dealer bleed hydraulic system.</li><li>• Check brake pads for wear.</li><li>• Replace if necessary.</li><li>• Check fluid level in reservoir.</li><li>• If necessary, add specified brake fluid to specified level.</li><li>• Check hydraulic system for leakage.</li></ul>	7-21, 7-22

# For your safety – pre-operation checks

ITEM	CHECKS	PAGE
<b>Rear brake</b>	<ul style="list-style-type: none"> <li>• Check operation.</li> <li>• If soft or spongy, have Yamaha dealer bleed hydraulic system.</li> <li>• Check brake pads for wear.</li> <li>• Replace if necessary.</li> <li>• Check fluid level in reservoir.</li> <li>• If necessary, add specified brake fluid to specified level.</li> <li>• Check hydraulic system for leakage.</li> </ul>	7-21, 7-22
<b>Clutch</b>	<ul style="list-style-type: none"> <li>• Check operation.</li> <li>• Lubricate cable if necessary.</li> <li>• Check lever free play.</li> <li>• Adjust if necessary.</li> </ul>	7-19
<b>Throttle grip</b>	<ul style="list-style-type: none"> <li>• Make sure that operation is smooth.</li> <li>• Check throttle grip free play.</li> <li>• If necessary, have Yamaha dealer adjust throttle grip free play and lubricate cable and grip housing.</li> </ul>	7-16, 7-26
<b>Control cables</b>	<ul style="list-style-type: none"> <li>• Make sure that operation is smooth.</li> <li>• Lubricate if necessary.</li> </ul>	7-25
<b>Drive chain</b>	<ul style="list-style-type: none"> <li>• Check chain slack.</li> <li>• Adjust if necessary.</li> <li>• Check chain condition.</li> <li>• Lubricate if necessary.</li> </ul>	7-23, 7-25
<b>Wheels and tires</b>	<ul style="list-style-type: none"> <li>• Check for damage.</li> <li>• Check tire condition and tread depth.</li> <li>• Check air pressure.</li> <li>• Correct if necessary.</li> </ul>	7-17, 7-18
<b>Brake and shift pedals</b>	<ul style="list-style-type: none"> <li>• Make sure that operation is smooth.</li> <li>• Lubricate pedal pivoting points if necessary.</li> </ul>	7-26
<b>Brake and clutch levers</b>	<ul style="list-style-type: none"> <li>• Make sure that operation is smooth.</li> <li>• Lubricate lever pivoting points if necessary.</li> </ul>	7-27
<b>Sidestand</b>	<ul style="list-style-type: none"> <li>• Make sure that operation is smooth.</li> <li>• Lubricate pivot if necessary.</li> </ul>	7-27

## For your safety – pre-operation checks

---

---

ITEM	CHECKS	PAGE
<b>Chassis fasteners</b>	<ul style="list-style-type: none"><li>• Make sure that all nuts, bolts and screws are properly tightened.</li><li>• Tighten if necessary.</li></ul>	–
<b>Instruments, lights, signals and switches</b>	<ul style="list-style-type: none"><li>• Check operation.</li><li>• Correct if necessary.</li></ul>	–

EAU15952

Read the Owner's Manual carefully to become familiar with all controls. If there is a control or function you do not understand, ask your Yamaha dealer.

## **WARNING**

**Failure to familiarize yourself with the controls can lead to loss of control, which could cause an accident or injury.**

EWA10272

EAU16842

## Engine break-in

There is never a more important period in the life of your engine than the period between 0 and 1600 km (1000 mi). For this reason, you should read the following material carefully.

Since the engine is brand new, do not put an excessive load on it for the first 1600 km (1000 mi). The various parts in the engine wear and polish themselves to the correct operating clearances. During this period, prolonged full-throttle operation or any condition that might result in engine overheating must be avoided.

EAU17104

### 0–1000 km (0–600 mi)

Avoid prolonged operation above 5000 r/min. **NOTICE: After 1000 km (600 mi) of operation, the engine oil must be changed and the oil filter element replaced.** [ECA11153]

### 1000–1600 km (600–1000 mi)

Avoid prolonged operation above 7500 r/min.

## 1600 km (1000 mi) and beyond

The vehicle can now be operated normally.

ECA10311

## **NOTICE**

- **Keep the engine speed out of the tachometer red zone.**
- **If any engine trouble should occur during the engine break-in period, immediately have a Yamaha dealer check the vehicle.**

# Operation and important riding points

---

## Starting the engine

EAU86710

The ignition circuit cut-off system will enable starting when:

- the transmission is in the neutral position or
- the transmission is in gear, the sidestand is up, and the clutch lever is pulled.

### To start the engine

1. Turn the main switch on and set the engine stop switch to the run position.
2. Confirm the indicator and warning light(s) come on for a few seconds, and the go off. (See page 4-3.)

### **TIP**

Do not start the engine if the engine trouble warning light remains on.

ECA26710

### **NOTICE**

**Do not continue to operate the vehicle if a warning light remains on. Have a Yamaha dealer check the vehicle.**

---

3. Shift the transmission into the neutral position.
4. Start the engine by pushing the start switch.
5. Release the start switch when the engine starts, or after 5 seconds. Wait 10 seconds before pressing the switch again to allow battery voltage to restore.

ECA11043

### **NOTICE**

**For maximum engine life, never accelerate hard when the engine is cold!**

---

EAUN0073

ECAN0072

### **NOTICE**

**Do not ride through deep water, otherwise the engine may be damaged. Avoid puddles because they may be deeper than expected.**

---



## Shifting

EAUJ2190

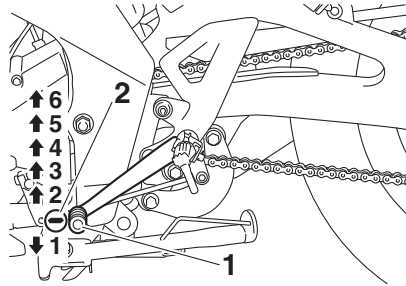

1. Shift pedal
2. Neutral position

Shifting gears lets you control the amount of engine power available for starting off, accelerating, climbing hills, etc.

### TIP

To shift the transmission into the neutral position (⊖), press the shift pedal down repeatedly until it reaches the end of its travel, and then slightly raise it.

### NOTICE

- Even with the transmission in the neutral position, do not coast for long periods of time with the engine off, and do not tow the motorcycle for long distances. The transmission is properly lubricated only when the engine is running. Inadequate lubrication may damage the transmission.
- Always use the clutch while changing gears to avoid damaging the engine, transmission, and drive train, which are not designed to withstand the shock of forced shifting.

ECA10261

## Tips for reducing fuel consumption

EAU16811

Fuel consumption depends largely on your riding style. Consider the following tips to reduce fuel consumption:

- Shift up swiftly, and avoid high engine speeds during acceleration.
- Do not rev the engine while shifting down, and avoid high engine speeds with no load on the engine.
- Turn the engine off instead of letting it idle for an extended length of time (e.g., in traffic jams, at traffic lights or at railroad crossings).

# Operation and important riding points

---

EAU17214

## Parking

When parking, stop the engine, and then remove the key from the main switch.

EWA10312

### **WARNING**

- Since the engine and exhaust system can become very hot, park in a place where pedestrians or children are not likely to touch them and be burned.
  - Do not park on a slope or on soft ground, otherwise the vehicle may overturn, increasing the risk of a fuel leak and fire.
  - Do not park near grass or other flammable materials which might catch fire.
-

# Periodic maintenance and adjustment

EAU17246

Periodic inspection, adjustment, and lubrication will keep your vehicle in the safest and most efficient condition possible. Safety is an obligation of the vehicle owner/operator. The most important points of vehicle inspection, adjustment, and lubrication are explained on the following pages.

The intervals given in the periodic maintenance charts should be simply considered as a general guide under normal riding conditions. However, depending on the weather, terrain, geographical location, and individual use, the maintenance intervals may need to be shortened.

## **! WARNING**

**Failure to properly maintain the vehicle or performing maintenance activities incorrectly may increase your risk of injury or death during service or while using the vehicle. If you are not familiar with vehicle service, have a Yamaha dealer perform service.**

EWA10322

EWA15123

## **! WARNING**

**Turn off the engine when performing maintenance unless otherwise specified.**

- **A running engine has moving parts that can catch on body parts or clothing and electrical parts that can cause shocks or fires.**
- **Running the engine while servicing can lead to eye injury, burns, fire, or carbon monoxide poisoning – possibly leading to death. See page 2-3 for more information about carbon monoxide.**

EWA15461

## **! WARNING**

**Brake discs, calipers, drums, and linings can become very hot during use. To avoid possible burns, let brake components cool before touching them.**

EAU85230

## Tool kit

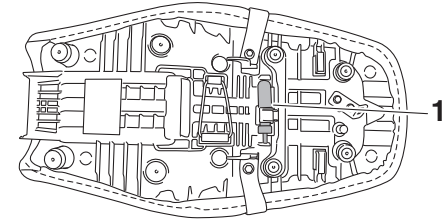

1. Tool kit

The tool kit is in the location shown. The information included in this manual and the tools provided in the tool kit are intended to assist you in the performance of preventive maintenance and minor repairs. However, a torque wrench and other tools are necessary to perform certain maintenance work correctly.

## TIP

If you do not have the tools or experience required for a particular job, have your Yamaha dealer perform it for you.

# Periodic maintenance and adjustment

EAUU0621

## TIP

- The annual checks must be performed every year, except if a kilometer-based maintenance is performed instead.
- From 20000 km, repeat the maintenance intervals starting from 4000 km.
- Items marked with an asterisk should be performed by a Yamaha dealer as they require special tools, data and technical skills.

EAUU1294

## Periodic maintenance chart for the emission control system

NO.	ITEM	CHECK OR MAINTENANCE JOB	ODOMETER READING (whichever comes first)					ANNUAL CHECK
			1000 km or 2 months	4000 km or 6 months	8000 km or 10 months	12000 km or 14 months	16000 km or 18 months	
1	* Fuel line	<ul style="list-style-type: none"> <li>• Check fuel hoses for cracks or damage.</li> </ul>		√	√	√	√	√
2	* Fuel filter	<ul style="list-style-type: none"> <li>• Check condition.</li> <li>• Replace if necessary.</li> </ul>	Every 12000 km (7500 mi)					
3	* Spark plug	<ul style="list-style-type: none"> <li>• Check condition.</li> <li>• Clean and regap.</li> </ul>		√	√	√	√	
		<ul style="list-style-type: none"> <li>• Replace.</li> </ul>	Every 8000 km (5000 mi)					
4	* Valves	<ul style="list-style-type: none"> <li>• Check valve clearance.</li> <li>• Adjust if necessary.</li> </ul>			√		√	
5	* Fuel injection	<ul style="list-style-type: none"> <li>• Adjust engine idling speed.</li> </ul>	√	√	√	√	√	√
6	* Exhaust system	<ul style="list-style-type: none"> <li>• Check for leakage.</li> <li>• Tighten if necessary.</li> <li>• Replace gasket(s) if necessary.</li> </ul>		√	√	√	√	√

# Periodic maintenance and adjustment

NO.	ITEM	CHECK OR MAINTENANCE JOB	ODOMETER READING (whichever comes first)					ANNUAL CHECK
			1000 km or 2 months	4000 km or 6 months	8000 km or 10 months	12000 km or 14 months	16000 km or 18 months	
7	*	<b>Evaporative emission control system</b>			√		√	

# Periodic maintenance and adjustment

EAUU1287

## General maintenance and lubrication chart

NO.	ITEM	CHECK OR MAINTENANCE JOB	ODOMETER READING (whichever comes first)					ANNUAL CHECK
			1000 km or 2 months	4000 km or 6 months	8000 km or 10 months	12000 km or 14 months	16000 km or 18 months	
1	* Diagnostic system check	<ul style="list-style-type: none"> <li>Perform dynamic inspection using Yamaha diagnostic tool.</li> <li>Check the error codes.</li> </ul>	√	√	√	√	√	√
2	* Air filter element	<ul style="list-style-type: none"> <li>Clean.</li> <li>Replace.</li> </ul>	√	√	√		√	√
3	Air filter check hose	<ul style="list-style-type: none"> <li>Clean.</li> </ul>	√	√	√	√	√	
4	* Battery	<ul style="list-style-type: none"> <li>Check voltage.</li> <li>Charge if necessary.</li> </ul>	√	√	√	√	√	√
5	Clutch	<ul style="list-style-type: none"> <li>Check operation.</li> <li>Adjust.</li> </ul>	√	√	√	√	√	
6	* Front brake	<ul style="list-style-type: none"> <li>Check operation, fluid level and vehicle for fluid leakage.</li> <li>Replace brake pads.</li> </ul>	√	√	√	√	√	√
7	* Rear brake	<ul style="list-style-type: none"> <li>Check operation, fluid level and vehicle for fluid leakage.</li> <li>Replace brake pads.</li> </ul>	√	√	√	√	√	√
8	* Brake hose	<ul style="list-style-type: none"> <li>Check for cracks or damage.</li> <li>Check for correct routing and clamping.</li> <li>Replace.</li> </ul>		√	√	√	√	√
9	* Brake fluid	<ul style="list-style-type: none"> <li>Change.</li> </ul>						
10	* Wheels	<ul style="list-style-type: none"> <li>Check runout and for damage.</li> </ul>		√	√	√	√	√

7

# Periodic maintenance and adjustment

NO.	ITEM	CHECK OR MAINTENANCE JOB	ODOMETER READING (whichever comes first)					ANNUAL CHECK
			1000 km or 2 months	4000 km or 6 months	8000 km or 10 months	12000 km or 14 months	16000 km or 18 months	
11	* Tires	<ul style="list-style-type: none"> <li>• Check tread depth and for damage.</li> <li>• Replace if necessary.</li> <li>• Check air pressure.</li> <li>• Correct if necessary.</li> </ul>		√	√	√	√	√
12	* Wheel bearings	<ul style="list-style-type: none"> <li>• Check bearings for looseness or damage.</li> </ul>		√	√	√	√	
13	* Swingarm	<ul style="list-style-type: none"> <li>• Check operation and for excessive play.</li> </ul>		√	√	√	√	
		<ul style="list-style-type: none"> <li>• Lubricate with lithium-soap-based grease.</li> </ul>	Every 24000 km (14000 mi)					
14	Drive chain	<ul style="list-style-type: none"> <li>• Check chain slack, alignment and condition.</li> <li>• Adjust and lubricate chain with a special O-ring chain lubricant thoroughly.</li> </ul>	Every 1000 km (600 mi) and after washing the motorcycle, riding in the rain or riding in wet areas					
15	* Steering bearings	<ul style="list-style-type: none"> <li>• Check bearing play and steering for roughness.</li> </ul>	√	√	√	√	√	
		<ul style="list-style-type: none"> <li>• Lubricate with lithium-soap-based grease.</li> </ul>	Every 24000 km (15000 mi)					
16	* Chassis fasteners	<ul style="list-style-type: none"> <li>• Make sure that all nuts, bolts and screws are properly tightened.</li> </ul>		√	√	√	√	√
17	Brake lever pivot shaft	<ul style="list-style-type: none"> <li>• Lubricate with silicone grease.</li> </ul>		√	√	√	√	√
18	Brake pedal pivot shaft	<ul style="list-style-type: none"> <li>• Lubricate with lithium-soap-based grease.</li> </ul>		√	√	√	√	√

# Periodic maintenance and adjustment

NO.	ITEM	CHECK OR MAINTENANCE JOB	ODOMETER READING (whichever comes first)					ANNUAL CHECK
			1000 km or 2 months	4000 km or 6 months	8000 km or 10 months	12000 km or 14 months	16000 km or 18 months	
19	Clutch lever pivot shaft	<ul style="list-style-type: none"> <li>Lubricate with lithium-soap-based grease.</li> </ul>		√	√	√	√	√
20	Shift pedal pivot shaft	<ul style="list-style-type: none"> <li>Lubricate with lithium-soap-based grease.</li> </ul>		√	√	√	√	√
21	Sidestand	<ul style="list-style-type: none"> <li>Check operation.</li> <li>Lubricate with lithium-soap-based grease.</li> </ul>		√	√	√	√	√
22 *	Front fork	<ul style="list-style-type: none"> <li>Check operation and for oil leakage.</li> </ul>		√	√	√	√	
23 *	Shock absorber assembly	<ul style="list-style-type: none"> <li>Check operation and shock absorber for oil leakage.</li> </ul>		√	√	√	√	
24	Engine oil	<ul style="list-style-type: none"> <li>Change.</li> <li>Check oil level and vehicle for oil leakage.</li> </ul>	√	√	√	√	√	
25	Engine oil filter element	<ul style="list-style-type: none"> <li>Replace.</li> </ul>	√		√		√	
26 *	Cooling system	<ul style="list-style-type: none"> <li>Check coolant level and vehicle for coolant leakage.</li> </ul>		√	√	√	√	√
		<ul style="list-style-type: none"> <li>Change with Yamaha genuine coolant.</li> </ul>	Every 3 years					
27 *	Front and rear brake switches	<ul style="list-style-type: none"> <li>Check operation.</li> </ul>	√	√	√	√	√	√
28	Moving parts and cables	<ul style="list-style-type: none"> <li>Lubricate.</li> </ul>		√	√	√	√	√



# Periodic maintenance and adjustment

NO.	ITEM	CHECK OR MAINTENANCE JOB	ODOMETER READING (whichever comes first)					ANNUAL CHECK
			1000 km or 2 months	4000 km or 6 months	8000 km or 10 months	12000 km or 14 months	16000 km or 18 months	
29	*	<b>Throttle grip</b>		√	√	√	√	√
30	*	<b>Lights, signals and switches</b>	√	√	√	√	√	√

EAU18662

## TIP

- The air filter needs more frequent service if you are riding in unusually wet or dusty areas.
- Hydraulic brake service
  - Regularly check and, if necessary, correct the brake fluid level.
  - Every two years replace the internal components of the brake master cylinder and caliper, and change the brake fluid.
  - Replace the brake hoses every four years and if cracked or damaged.

# Periodic maintenance and adjustment

## Removing and installing cowlings

EAU18782

The cowlings shown need to be removed to perform some of the maintenance jobs described in this chapter. Refer to this section each time a cowling needs to be removed and installed.

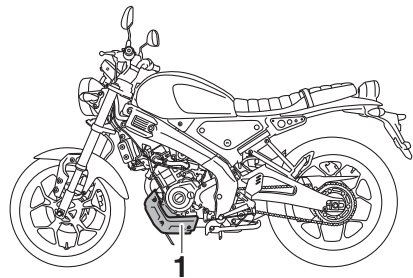

1. Cowling A

## Cowling A

EAU46742

### To remove the cowling

Remove the bolts, and then take the cowling off.

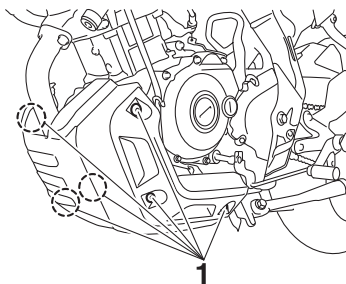

1. Cowling A

### To install the cowling

Place the cowling in the original position, and then install the bolts.

## Checking the spark plug

EAU19614

The spark plug is an important engine component, which is easy to check. Since heat and deposits will cause any spark plug to slowly erode, the spark plug should be removed and checked in accordance with the periodic maintenance and lubrication chart. In addition, the condition of the spark plug can reveal the condition of the engine.

### To remove the spark plug

1. Remove the spark plug cap.

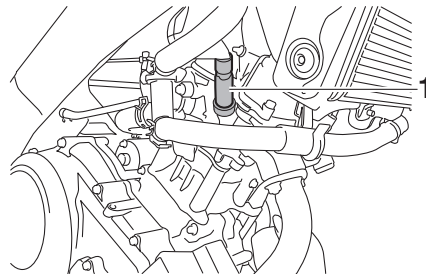

1. Spark plug cap

2. Remove the spark plug as shown, with a spark plug wrench available at a Yamaha dealer.

# Periodic maintenance and adjustment

## To check the spark plug

1. Check that the porcelain insulator around the center electrode of the spark plug is a medium-to-light tan (the ideal color when the vehicle is ridden normally).

### TIP

If the spark plug shows a distinctly different color, the engine could be operating improperly. Do not attempt to diagnose such problems yourself. Instead, have a Yamaha dealer check the vehicle.

2. Check the spark plug for electrode erosion and excessive carbon or other deposits, and replace it if necessary.

**Specified spark plug:**  
NGK/MR8E9

3. Measure the spark plug gap with a wire thickness gauge and, if necessary, adjust the gap to specification.

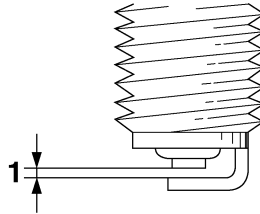

1. Spark plug gap

**Spark plug gap:**  
0.8–0.9 mm (0.031–0.035 in)

## To install the spark plug

1. Clean the surface of the spark plug gasket and its mating surface, and then wipe off any grime from the spark plug threads.
2. Install the spark plug with the spark plug wrench, and then tighten it to the specified torque.

**Tightening torque:**  
Spark plug:  
13 N·m (1.3 kgf·m, 9.6 lb·ft)

### TIP

If a torque wrench is not available when installing a spark plug, a good estimate of the correct torque is 1/4–1/2 turn past finger tight. However, the spark plug should be tightened to the specified torque as soon as possible.

3. Install the spark plug cap.

# Periodic maintenance and adjustment

## Canister

EAU36112

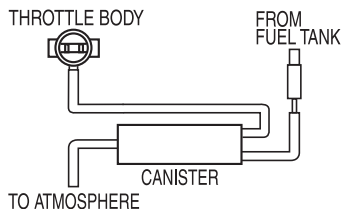

This model is equipped with a canister to prevent the discharging of fuel vapor into the atmosphere. Before operating this vehicle, make sure to check the following:

- Check each hose connection.
- Check each hose and canister for cracks or damage. Replace if damaged.
- Make sure that the canister breather is not blocked, and if necessary, clean it.

## Engine oil and oil filter element

EAU0453

The engine oil level should be checked before each ride. In addition, the oil must be changed and the oil filter element replaced at the intervals specified in the periodic maintenance and lubrication chart.

### To check the engine oil level

1. Place the vehicle on a level surface and hold it in an upright position. A slight tilt to the side can result in a false reading.
2. Start the engine, warm it up for several minutes, and then turn it off.
3. Wait a few minutes until the oil settles, remove the oil filler cap, wipe the dipstick clean, insert it back into the oil filler hole (without screwing it in), and then remove it again to check the oil level.

**NOTICE:** Do not operate the vehicle until you know that the engine oil level is sufficient. [ECA10012]

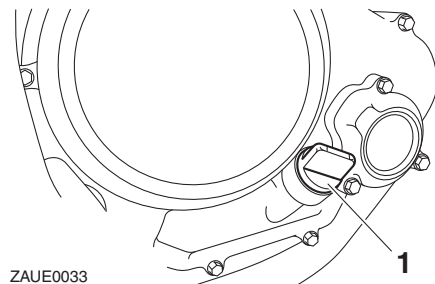

ZAUE0033

1. Engine oil filler cap

### TIP

The engine oil should be between the minimum and maximum level marks.

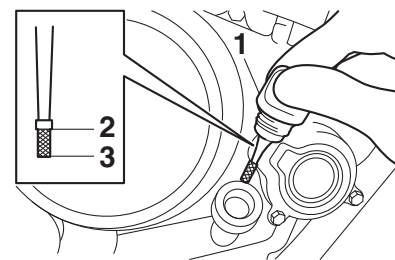

ZAUE1300

1. Dipstick
2. Maximum level mark
3. Tip of the engine oil dipstick

# Periodic maintenance and adjustment

4. If the engine oil is below the minimum level mark, add sufficient oil of the recommended type to raise it to the correct level.
5. Install and tighten the oil filler cap.

## To change the engine oil (with or without oil filter element replacement)

1. Start the engine, warm it up for several minutes, and then turn it off.
2. Place an oil pan under the engine to collect the used oil.
3. Remove the engine oil filler cap, then the drain bolt along with the O-ring, compression spring, and engine oil strainer, to drain the oil from the crankcase. **NOTICE:** When removing the engine oil drain bolt, the O-ring, compression spring, and oil strainer will fall out. Take care not to lose these parts. [ECA11002]

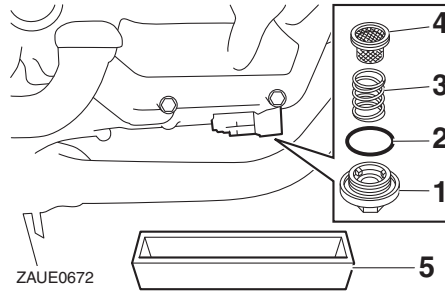

ZAU E0672

1. Engine oil drain bolt
2. O-ring
3. Compression spring
4. Strainer
5. Oil pan

4. Clean the engine oil strainer with solvent.

### TIP

Skip steps 5–7 if the oil filter element is not being replaced.

5. Remove the oil filter element cover by removing the bolts.

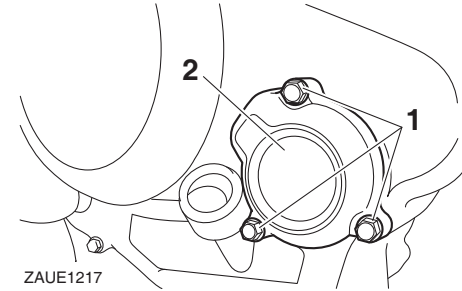

ZAU E1217

1. Bolt
2. Oil filter element cover

6. Remove and replace the oil filter element and O-ring.

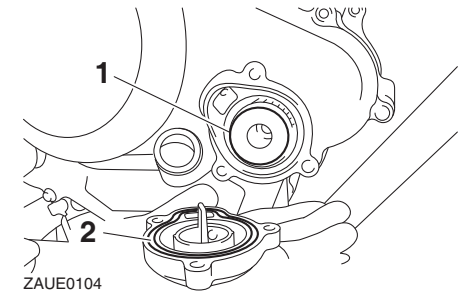

ZAU E0104

1. Oil filter element
2. O-ring

# Periodic maintenance and adjustment

7. Install the oil filter element cover by installing the bolts, then tightening them to the specified torque.

## Tightening torques:

Oil filter element cover bolt:  
10 N·m (1.0 kgf·m, 7.4 lb·ft)

## TIP

Make sure that the O-ring is properly seated.

8. Install the engine oil strainer, compression spring, O-ring and the engine oil drain bolt, and then tighten it to the specified torque.  
**NOTICE:** Before installing the engine oil drain bolt, do not forget to install the O-ring, compression spring, and oil strainer in position. [ECA10422]

## Tightening torques:

Engine oil drain bolt:  
32 N·m (3.2 kgf·m, 24 lb·ft)

9. Refill with the specified amount of the recommended engine oil, and then install and tighten the oil filler cap.

## Recommended engine oil:

See page 9-1.

## Oil quantity:

Oil change:

0.85 L (0.90 US qt, 0.75 Imp.qt)

With oil filter removal:

0.95 L (1.00 US qt, 0.84 Imp.qt)

ECA11621

## NOTICE

- In order to prevent clutch slippage (since the engine oil also lubricates the clutch), do not mix any chemical additives. Do not use oils with a diesel specification of “CD” or oils of a higher quality than specified. In addition, do not use oils labeled “ENERGY CONSERVING II” or higher.
- Make sure that no foreign material enters the crankcase.

10. Start the engine, and then let it idle for several minutes while checking it for oil leakage. If oil is leaking, immediately turn the engine off and check for the cause.
11. Turn the engine off, and then check the oil level and correct it if necessary.

## Why Yamalube

EAU85450

YAMALUBE oil is a Genuine YAMAHA Part born of the engineers' passion and belief that engine oil is an important liquid engine component. We form teams of specialists in the fields of mechanical engineering, chemistry, electronics and track testing, and have them develop the engine together with the oil it will use. Yamalube oils take full advantage of the base oil's qualities and blend in the ideal balance of additives to make sure the final oil clears our performance standards. Thus, Yamalube mineral, semisynthetic and synthetic oils have their own distinct characters and value. Yamaha's experience gained over many years of research and development into oil since the 1960's helps make Yamalube the best choice for your Yamaha engine.

# YAMALUBE®

EAU20071

## Coolant

The coolant level should be checked before each ride. In addition, the coolant must be changed at the intervals specified in the periodic maintenance and lubrication chart.

EAU80890

### To check the coolant level

1. Place the vehicle on a level surface.
2. Remove cowling A. (See page 7-8.)
3. Hold the vehicle in an upright position.

### TIP

- The coolant level must be checked on a cold engine since the level varies with engine temperature.
- Make sure that the vehicle is positioned straight up when checking the coolant level. A slight tilt to the side can result in a false reading.

4. Check the coolant level in the coolant reservoir.

### TIP

The coolant should be between the minimum and maximum level marks.

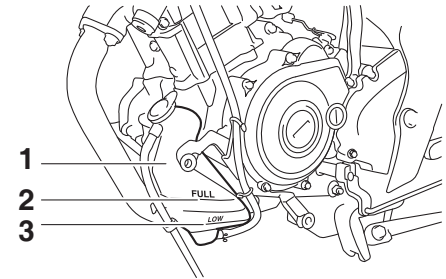

1. Coolant reservoir
2. Maximum level mark
3. Minimum level mark

5. If the coolant is at or below the minimum level mark, remove the coolant reservoir cap.

# Periodic maintenance and adjustment

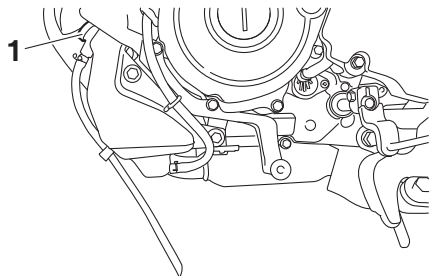

1. Coolant reservoir cap

6. Add coolant to the maximum level mark, and then install the coolant reservoir cap. **WARNING! Remove only the coolant reservoir cap. Never attempt to remove the radiator cap when the engine is hot.** [EWA15162] **NOTICE: If coolant is not available, use distilled water or soft tap water instead. Do not use hard water or salt water since it is harmful to the engine. If water has been used instead of coolant, replace it with coolant as soon as possible, otherwise the cooling system will not be protected against frost and corrosion. If water has been added to the**

coolant, have a Yamaha dealer check the antifreeze content of the coolant as soon as possible, otherwise the effectiveness of the coolant will be reduced.

[ECA10473]

**Coolant reservoir capacity (up to the maximum level mark):**  
0.15 L (0.16 US qt, 0.13 Imp.qt)

7. Install the cowling.

## Changing the coolant

EAU33032

The coolant must be changed at the intervals specified in the periodic maintenance and lubrication chart. Have a Yamaha dealer change the coolant. **WARNING! Never attempt to remove the radiator cap when the engine is hot.** [EWA10382]

EAUJ2170

## Air filter element and check hose

The air filter element should be cleaned or replaced by a Yamaha dealer at the intervals specified in the periodic maintenance chart. Have the air filter element serviced more frequently if you often ride in wet or dusty areas. In addition, the air filter check hose should be regularly checked and cleaned if necessary.

## To clean the air filter check hose

1. Check the hose for accumulated dirt or water.

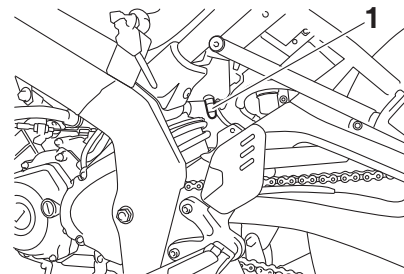

1. Air filter check hose



# Periodic maintenance and adjustment

2. If dirt or water is visible, remove the hose, clean it and then install it.

## Adjusting the engine idling speed

EAU34302

The engine idling speed must be checked and, if necessary, adjusted as follows at the intervals specified in the periodic maintenance and lubrication chart.

The engine should be warm before making this adjustment.

Check the engine idling speed and, if necessary, adjust it to specification by turning the idle adjusting screw. To increase the engine idling speed, turn the screw in direction (a). To decrease the engine idling speed, turn the screw in direction (b).

**Engine idling speed:**  
1300–1500 r/min

### TIP

If the specified idling speed cannot be obtained as described above, have a Yamaha dealer make the adjustment.

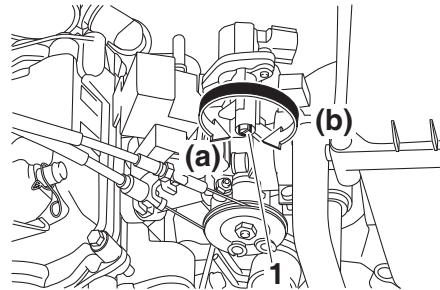

1. Idle adjusting screw

# Periodic maintenance and adjustment

## Adjusting the throttle grip free play

EAU21377

Measure the throttle grip free play as shown.

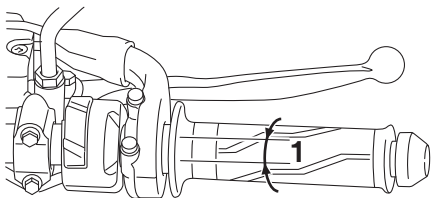

1. Throttle grip free play

**Throttle grip free play:**  
3.0–5.0 mm (0.12–0.20 in)

Periodically check the throttle grip free play and, if necessary, adjust it as follows.

### TIP

The engine idling speed must be correctly adjusted before checking and adjusting the throttle grip free play.

1. Loosen the locknut.

2. To increase the throttle grip free play, turn the throttle grip free play adjusting nut in direction (a). To decrease the throttle grip free play, turn the adjusting nut in direction (b).

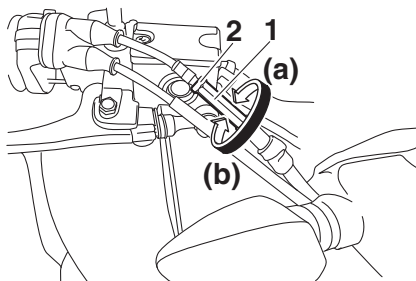

1. Locknut
2. Adjusting nut
3. Tighten the locknut.

EAU21403

## Valve clearance

The valves are an important engine component, and since valve clearance changes with use, they must be checked and adjusted at the intervals specified in the periodic maintenance chart. Unadjusted valves can result in improper air-fuel mixture, engine noise, and eventually engine damage. To prevent this from occurring, have your Yamaha dealer check and adjust the valve clearance at regular intervals.

### TIP

This service must be performed when the engine is cold.

# Periodic maintenance and adjustment

## Tires

EAU82721

Tires are the only contact between the vehicle and the road. Safety in all conditions of riding depends on a relatively small area of road contact. Therefore, it is essential to maintain the tires in good condition at all times and replace them at the appropriate time with the specified tires.

## Tire air pressure

The tire air pressure should be checked and, if necessary, adjusted before each ride.

EWA10504

### **⚠ WARNING**

**Operation of this vehicle with improper tire pressure may cause severe injury or death from loss of control.**

- The tire air pressure must be checked and adjusted on cold tires (i.e., when the temperature of the tires equals the ambient temperature).
- The tire air pressure must be adjusted in accordance with the riding speed and with the total

**weight of rider, passenger, cargo, and accessories approved for this model.**

### **Cold tire air pressure:**

#### **1 person:**

Front:

225 kPa (2.25 kgf/cm<sup>2</sup>, 33 psi)

Rear:

250 kPa (2.50 kgf/cm<sup>2</sup>, 36 psi)

#### **2 persons:**

Front:

225 kPa (2.25 kgf/cm<sup>2</sup>, 33 psi)

Rear:

250 kPa (2.50 kgf/cm<sup>2</sup>, 36 psi)

### **Maximum load:**

Vehicle:

172 kg (379 lb)

The vehicle's maximum load is the combined weight of the rider, passenger, cargo, and any accessories.

EWA10512

### **⚠ WARNING**

**Never overload your vehicle. Operation of an overloaded vehicle could cause an accident.**

## Tire inspection

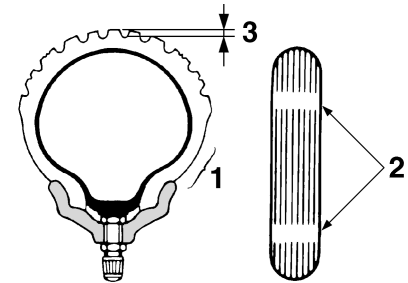

1. Tire sidewall
2. Tire wear indicator
3. Tire tread depth

The tires must be checked before each ride. If a tire tread shows crosswise lines (minimum tread depth), if the tire has a nail or glass fragments in it, or if the sidewall is cracked, contact a Yamaha dealer immediately and have the tire replaced.

**Minimum tire tread depth (front and rear):**

1.0 mm (0.04 in)

# Periodic maintenance and adjustment

EWA10583

## WARNING

- It is dangerous to ride with a worn-out tire. When a tire tread begins to show crosswise lines, have a Yamaha dealer replace the tire immediately.
- The replacement of all wheel and brake-related parts, including the tires, should be left to a Yamaha dealer, who has the necessary professional knowledge and experience to do so.
- Ride at moderate speeds after changing a tire since the tire surface must first be “broken in” for it to develop its optimal characteristics.

## Tire information

This model is equipped with tubeless tires and tire air valves.

Tires age, even if they have not been used or have only been used occasionally. Cracking of the tread and sidewall rubber, sometimes accompanied by carcass deformation, is an evidence of

ageing. Old and aged tires shall be checked by tire specialists to ascertain their suitability for further use.

EWA10462

## WARNING

**The front and rear tires should be of the same make and design, otherwise the handling characteristics of the vehicle may be different, which could lead to an accident.**

After extensive tests, only the tires listed below have been approved for this model by Yamaha.

### Front tire:

Size:

110/70-17 M/C 54S

Manufacturer/model:

IRC/TRAIL WINNER GP-211F

### Rear tire:

Size:

140/70-17 M/C 66S

Manufacturer/model:

IRC/TRAIL WINNER GP-211R

EAU21963

## Cast wheels

To maximize the performance, durability, and safe operation of your vehicle, note the following points regarding the specified wheels.

- The wheel rims should be checked for cracks, bends, warp-age or other damage before each ride. If any damage is found, have a Yamaha dealer replace the wheel. Do not attempt even the smallest repair to the wheel. A deformed or cracked wheel must be replaced.
- The wheel should be balanced whenever either the tire or wheel has been changed or replaced. An unbalanced wheel can result in poor performance, adverse handling characteristics, and a shortened tire life.

# Periodic maintenance and adjustment

## Adjusting the clutch lever free play EAU22047

Measure the clutch lever free play as shown.

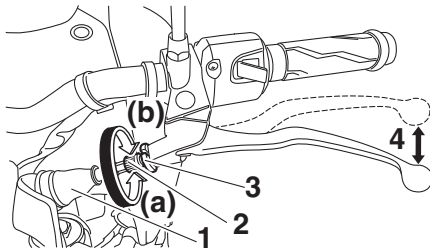

1. Rubber cover
2. Clutch lever free play adjusting bolt
3. Locknut
4. Clutch lever free play

**Clutch lever free play:**  
8.0–13.0 mm (0.31–0.51 in)

Periodically check the clutch lever free play and, if necessary, adjust it as follows.

1. Slide the rubber cover back at the clutch lever.
2. Loosen the locknut.

3. To increase the clutch lever free play, turn the clutch lever free play adjusting bolt in direction (a). To decrease the clutch lever free play, turn the adjusting bolt in direction (b).

### TIP

If the specified clutch lever free play could be obtained as described above, skip steps 4–7.

4. Fully turn the adjusting bolt at the clutch lever in direction (a) to loosen the clutch cable.
5. Loosen the locknut at the crankcase.

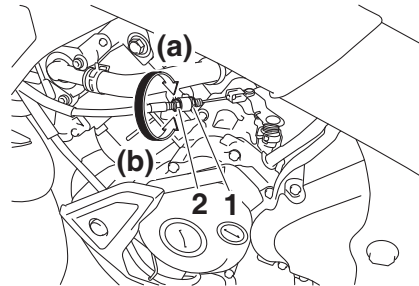

1. Locknut
2. Clutch lever free play adjusting nut

6. To increase the clutch lever free play, turn the clutch lever free play adjusting nut in direction (a). To decrease the clutch lever free play, turn the adjusting nut in direction (b).
7. Tighten the locknut at the crankcase.
8. Tighten the locknut at the clutch lever and then slide the rubber cover to its original position.

# Periodic maintenance and adjustment

## Checking the brake lever free play

EAU37914

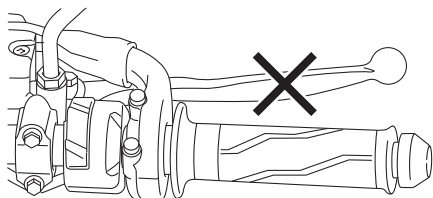

### 1. Front brake lever

There should be no free play at the brake lever end. If there is free play, have a Yamaha dealer inspect the brake system.

EWA14212

### **WARNING**

**A soft or spongy feeling in the brake lever can indicate the presence of air in the hydraulic system. If there is air in the hydraulic system, have a Yamaha dealer bleed the system before operating the vehicle. Air in the hydraulic system will diminish the**

**braking performance, which may result in loss of control and an accident.**

## Brake light switches

EAU22275

The brake light is activated by switches connected to the brake lever and brake pedal. Check that the brake light comes on just before braking takes effect. If necessary, adjust the rear brake light switch as follows.

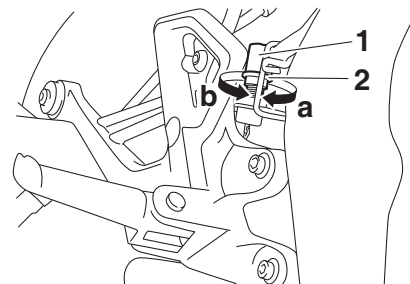

1. Rear brake light switch
2. Rear brake light switch adjusting nut

Turn the rear brake light switch adjusting nut while holding the rear brake light switch in place. To make the brake light come on earlier, turn the adjusting nut in direction (a). To make the brake light come on later, turn the adjusting nut in direction (b).

# Periodic maintenance and adjustment

**TIP** \_\_\_\_\_  
The front brake light switch should be serviced by a Yamaha dealer.

## Checking the front and rear brake pads EAU22393

The front and rear brake pads must be checked for wear at the intervals specified in the periodic maintenance and lubrication chart.

### Front brake pads EAU22433

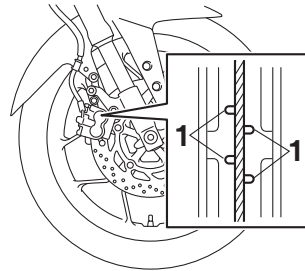

1. Brake pad wear indicator groove

Each front brake pad is provided with wear indicator grooves, which allow you to check the brake pad wear without having to disassemble the brake. To check the brake pad wear, check the wear indicator grooves. If a brake pad has worn to the point that the wear

indicator grooves have almost disappeared, have a Yamaha dealer replace the brake pads as a set.

### Rear brake pads EAU36721

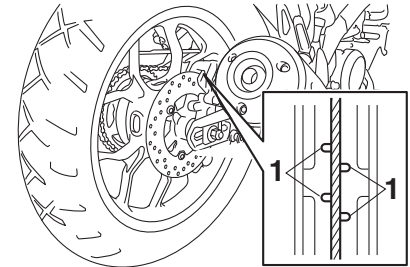

1. Brake pad wear indicator groove

Each rear brake pad is provided with wear indicator grooves, which allow you to check the brake pad wear without having to disassemble the brake. To check the brake pad wear, check the wear indicator grooves. If a brake pad has worn to the point that the wear indicator grooves have almost disappeared, have a Yamaha dealer replace the brake pads as a set.

# Periodic maintenance and adjustment

EAUJ0530

## Checking the brake fluid level

Before riding, check that the brake fluid is above the minimum level mark. Check the brake fluid level with the top of the reservoir level. Replenish the brake fluid if necessary.

### Front brake

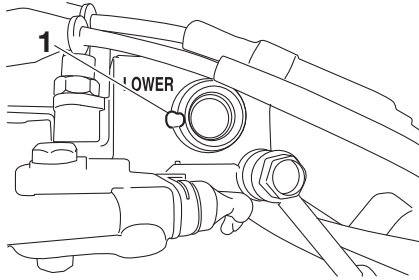

1. Minimum level mark

### Rear brake

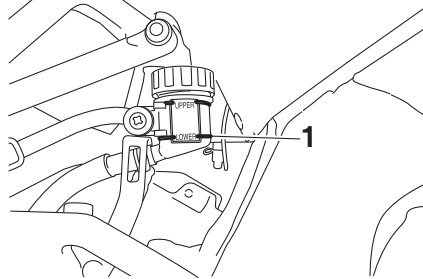

1. Minimum level mark

**Specified brake fluid:**  
DOT 3 or DOT 4

EWA15981

### **WARNING**

Improper maintenance can result in loss of braking ability. Observe these precautions:

- Insufficient brake fluid may allow air to enter the brake system, reducing braking performance.
- Clean the filler cap before removing. Use only DOT 3 or DOT 4 brake fluid from a sealed container.

- Use only the specified brake fluid; otherwise, the rubber seals may deteriorate, causing leakage.
- Refill with the same type of brake fluid. Adding a brake fluid other than DOT 3 or DOT 4 may result in a harmful chemical reaction.
- Be careful that water does not enter the brake fluid reservoir when refilling. Water will significantly lower the boiling point of the fluid and may result in vapor lock.

### **NOTICE**

Brake fluid may damage painted surfaces or plastic parts. Always clean up spilled fluid immediately.

As the brake pads wear, it is normal for the brake fluid level to gradually go down. A low brake fluid level may indicate worn brake pads and/or brake system leakage; therefore, be sure to check the brake pads for wear and the brake system for leakage. If the brake

ECA17641



# Periodic maintenance and adjustment

fluid level goes down suddenly, have a Yamaha dealer check the cause before further riding.

## Changing the brake fluid

EAUM1362

Have a Yamaha dealer change the brake fluid at the intervals specified in the periodic maintenance and lubrication chart. In addition, have the brake hose replaced every four years and whenever it is damaged or leaking.

## Drive chain slack

EAU22762

The drive chain slack should be checked before each ride and adjusted if necessary.

### To check the drive chain slack

EAU74253

1. Place the motorcycle on the side-stand.

### TIP

When checking and adjusting the drive chain slack, there should be no weight on the motorcycle.

2. Shift the transmission into the neutral position.
3. Measure the drive chain slack as shown.

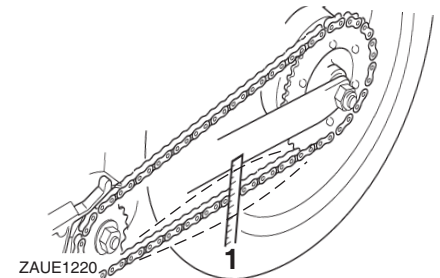

ZAUE1220

1. Drive chain slack

# Periodic maintenance and adjustment

## Drive chain slack:

30.0–40.0 mm (1.18–1.57 in)

4. If the drive chain slack is incorrect, adjust it as follows. **NOTICE: Improper drive chain slack will overload the engine as well as other vital parts of the motorcycle and can lead to chain slippage or breakage. To prevent this from occurring, keep the drive chain slack within the specified limits.** [ECA10572]

EAU3431B

## 7 To adjust the drive chain slack

Consult a Yamaha dealer before adjusting the drive chain slack.

1. Loosen the axle nut and the locknut on each side of the swingarm.

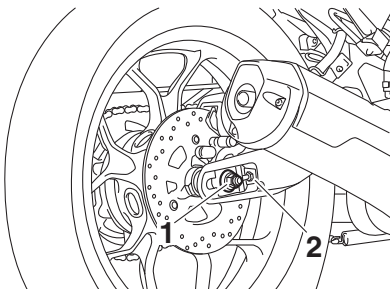

1. Axle nut
2. Locknut

2. To tighten the drive chain, turn the drive chain slack adjusting bolt on each side of the swingarm in direction (a). To loosen the drive chain, turn the adjusting bolt on each side of the swingarm in direction (b), and then push the rear wheel forward.

### TIP

Using the alignment marks on each side of the swingarm, make sure that both drive chain pullers are in the same position for proper wheel alignment.

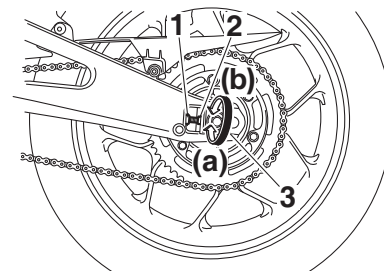

1. Locknut
2. Drive chain slack adjusting bolt
3. Alignment marks

3. Tighten the axle nut, then the locknuts to their specified torques.

### Tightening torques:

Axle nut:

59 N·m (5.9 kgf·m, 44 lb-ft)

Locknut:

16 N·m (1.6 kgf·m, 12 lb-ft)

4. Make sure that the drive chain pullers are in the same position, the drive chain slack is correct, and the drive chain moves smoothly.

## Cleaning and lubricating the drive chain <sup>EAUE0141</sup>

The drive chain must be cleaned and lubricated at the intervals specified in the periodic maintenance and lubrication chart, otherwise it will quickly wear out, especially when riding in dusty or wet areas. Service the drive chain as follows.

ECA10584

### **NOTICE**

**The drive chain must be lubricated after washing the motorcycle, riding in the rain or riding in wet areas.**

1. Clean the drive chain with soap water to remove the accumulated dust & mud and then dry off.
2. Apply the cleaning spray on all the links and plates of chain, then wipe the chain. **NOTICE: To prevent damaging the O-rings, do not clean the drive chain with steam cleaners, high-pressure washers or inappropriate solvents.** [ECA11122]

3. Thoroughly lubricate the drive chain with a special O-ring chain lubricant.

## Checking and lubricating the cables <sup>EAU23098</sup>

The operation of all control cables and the condition of the cables should be checked before each ride, and the cables and cable ends should be lubricated if necessary. If a cable is damaged or does not move smoothly, have a Yamaha dealer check or replace it. **WARNING! Damage to the outer housing of cables may result in internal rusting and cause interference with cable movement. Replace damaged cables as soon as possible to prevent unsafe conditions.** [EWA10712]

### **Recommended lubricant:**

Yamaha cable lubricant or other suitable cable lubricant

# Periodic maintenance and adjustment

## Checking and lubricating the throttle grip and cable end

EAU44276

The operation of the throttle grip should be checked before each ride. In addition, the cable end should be lubricated by a Yamaha dealer at the intervals specified in the periodic maintenance chart.

The throttle cable is equipped with a rubber cover. Make sure that the cover is securely installed. Even though the cover is installed correctly, it does not completely protect the cable from water entry. Therefore, use care not to pour water directly onto the cover or cable when washing the vehicle. If the cable or cover becomes dirty, wipe clean with a moist cloth.

## Checking and lubricating the brake and shift pedals

EAU44276

The operation of the brake and shift pedals should be checked before each ride, and the pedal pivots should be lubricated if necessary.

### Brake pedal

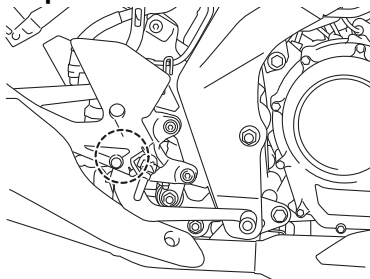

### Shift pedal

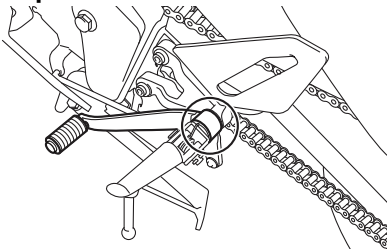

**Recommended lubricant:**  
Lithium-soap-based grease

# Periodic maintenance and adjustment

## Checking and lubricating the brake and clutch levers

EAU23144

The operation of the brake and clutch levers should be checked before each ride, and the lever pivots should be lubricated if necessary.

### Brake lever

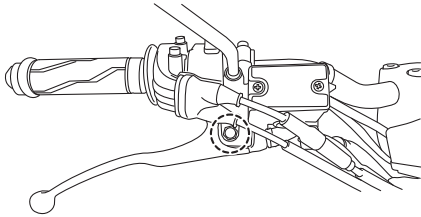

### Clutch lever

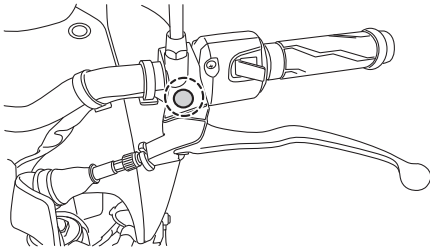

### Recommended lubricants:

Brake lever:

Silicone grease

Clutch lever:

Lithium-soap-based grease

## Checking and lubricating the sidestand

EAU23203

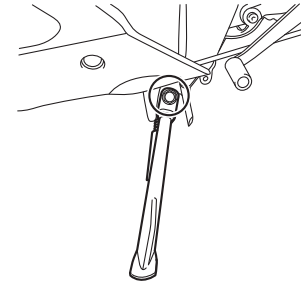

The operation of the sidestand should be checked before each ride, and the sidestand pivot and metal-to-metal contact surfaces should be lubricated if necessary.

7

### **⚠ WARNING**

If the sidestand does not move up and down smoothly, have a Yamaha dealer check or repair it. Otherwise, the sidestand could contact the ground and distract the operator, resulting in a possible loss of control.

EWA10732

### Recommended lubricant:

Lithium-soap-based grease

# Periodic maintenance and adjustment

## Lubricating the swingarm pivots

EAUM1653

The swingarm pivots must be lubricated by a Yamaha dealer at the intervals specified in the periodic maintenance and lubrication chart.

**Recommended lubricant:**  
Lithium-soap-based grease

## Checking the front fork

EAU23273

The condition and operation of the front fork must be checked as follows at the intervals specified in the periodic maintenance and lubrication chart.

### To check the condition

Check the inner tubes for scratches, damage and excessive oil leakage.

### To check the operation

1. Place the vehicle on a level surface and hold it in an upright position. **WARNING! To avoid injury, securely support the vehicle so there is no danger of it falling over.** [EWA10752]
2. While applying the front brake, push down hard on the handlebars several times to check if the front fork compresses and rebounds smoothly.

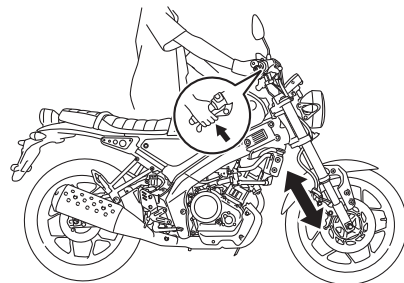

ECA10591

### **NOTICE**

**If any damage is found or the front fork does not operate smoothly, have a Yamaha dealer check or repair it.**

## Checking the steering

EAU23285

Worn or loose steering bearings may cause danger. Therefore, the operation of the steering must be checked as follows at the intervals specified in the periodic maintenance and lubrication chart.

1. Raise the front wheel off the ground. (See page 7-32.)  
**WARNING! To avoid injury, securely support the vehicle so there is no danger of it falling over.** [EWA10752]
2. Hold the lower ends of the front fork legs and try to move them forward and backward. If any free play can be felt, have a Yamaha dealer check or repair the steering.

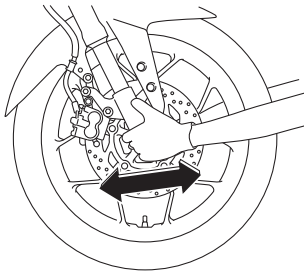

## Checking the wheel bearings

EAU23292

The front and rear wheel bearings must be checked at the intervals specified in the periodic maintenance and lubrication chart. If there is play in the wheel hub or if the wheel does not turn smoothly, have a Yamaha dealer check the wheel bearings.

## Battery

EAU23377

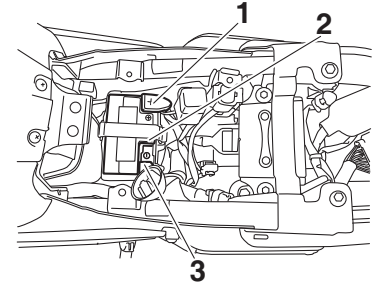

1. Positive battery lead (red)
2. Battery
3. Negative battery lead (black)

This model is equipped with a VRLA (Valve Regulated Lead Acid) battery. There is no need to check the electrolyte or to add distilled water. However, the battery lead connections need to be checked and, if necessary, tightened.

7

### **⚠ WARNING**

EWA10761

- **Electrolyte is poisonous and dangerous since it contains sulfuric acid, which causes severe burns. Avoid any contact with skin, eyes or clothing and al-**

# Periodic maintenance and adjustment

---

ways shield your eyes when working near batteries. In case of contact, administer the following **FIRST AID**.

- **EXTERNAL:** Flush with plenty of water.
- **INTERNAL:** Drink large quantities of water or milk and immediately call a physician.
- **EYES:** Flush with water for 15 minutes and seek prompt medical attention.
- Batteries produce explosive hydrogen gas. Therefore, keep sparks, flames, cigarettes, etc., away from the battery and provide sufficient ventilation when charging it in an enclosed space.
- **KEEP THIS AND ALL BATTERIES OUT OF THE REACH OF CHILDREN.**

ECA10621

## **NOTICE**

---

Never attempt to remove the battery cell seals, as this would permanently damage the battery.

---

## **To charge the battery**

Have a Yamaha dealer charge the battery as soon as possible if it seems to have discharged. Keep in mind that the battery tends to discharge more quickly if the vehicle is equipped with optional electrical accessories.

ECA16522

## **NOTICE**

---

**To charge a VRLA (Valve Regulated Lead Acid) battery, a special (constant-voltage) battery charger is required. Using a conventional battery charger will damage the battery.**

---

## **To store the battery**

1. If the vehicle will not be used for more than one month, remove the battery, fully charge it, and then place it in a cool, dry place. **NOTICE: When removing the battery, be sure to turn the main switch off, then disconnect the negative lead before disconnecting the positive lead.** [ECA16304]
2. If the battery will be stored for more than two months, check it at least once a month and fully charge it if necessary.

3. Fully charge the battery before installation. **NOTICE: When installing the battery, be sure to turn the main switch off, then connect the positive lead before connecting the negative lead.**

[ECA16842]

4. After installation, make sure that the battery leads are properly connected to the battery terminals.

ECA16531

## **NOTICE**

---

**Always keep the battery charged. Storing a discharged battery can cause permanent battery damage.**

---



EAU53044

## Replacing the fuses

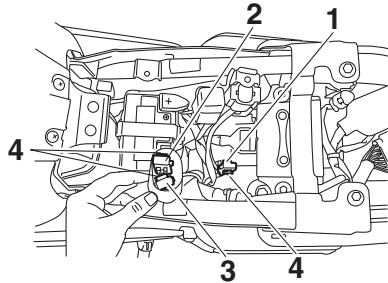

1. Main fuse
2. Sub fuse
3. Terminal fuse 1
4. Spare fuse

The fuse box is located under the rider seat.

If a fuse is blown, replace it as follows.

1. Turn the main switch off and turn off the electrical circuit in question.
2. Remove the blown fuse, and then install a new fuse of the specified amperage. **WARNING! Do not use a fuse of a higher amperage rating than recommended to**

**avoid causing extensive damage to the electrical system and possibly a fire.** [EWA15132]

### Specified fuses:

- Main fuse:  
15.0 A
- Sub fuse:  
7.5 A
- Terminal fuse 1:  
2.0 A

3. Turn the main switch on and turn on the electrical circuit in question to check if the device operates.
4. If the fuse immediately blows again, have a Yamaha dealer check the electrical system.

EAUN2261

## Vehicle lights

This model is equipped with LED lights for headlights, auxiliary lights and brake/tail light. If a light does not come on, check the fuse and then have a Yamaha dealer check the vehicle.

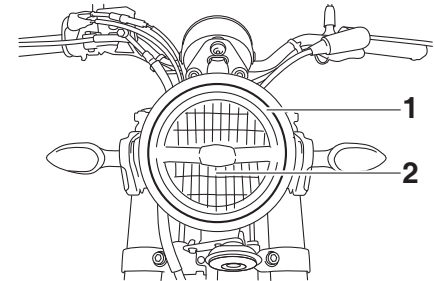

1. Auxiliary light
2. Headlight

ECA16581

### **NOTICE**

**Do not affix any type of tinted film or stickers to the headlight lens.**

# Periodic maintenance and adjustment

## Replacing a turn signal light bulb

EAU24205

1. Remove the turn signal light lens by removing the screw.

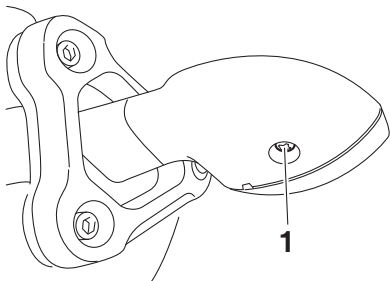

1. Screw

2. Remove the burnt-out bulb by pushing it in and turning it counterclockwise.
3. Insert a new bulb into the socket, push it in, and then turn it clockwise until it stops.
4. Install the lens by installing the screw. **NOTICE: Do not over-tighten the screw, otherwise the lens may break.** [ECA11192]

## Supporting the motorcycle

EAU24351

Since this model is not equipped with a centerstand, follow these precautions when removing the front and rear wheel or performing other maintenance requiring the motorcycle to stand upright. Check that the motorcycle is in a stable and level position before starting any maintenance. A strong wooden box can be placed under the engine for added stability.

### To service the front wheel

1. Stabilize the rear of the motorcycle by using a motorcycle stand or, if an additional motorcycle stand is not available, by placing a jack under the frame in front of the rear wheel.
2. Raise the front wheel off the ground by using a motorcycle stand.

### To service the rear wheel

Raise the rear wheel off the ground by using a motorcycle stand or, if a motorcycle stand is not available, by placing

a jack either under each side of the frame in front of the rear wheel or under each side of the swingarm.

# Periodic maintenance and adjustment

## Front wheel

EAU24361

EAUN0582

### To remove the front wheel

EWA10822

#### **WARNING**

To avoid injury, securely support the vehicle so there is no danger of it falling over.

1. Loosen the front wheel axle nut and the brake caliper bolts.

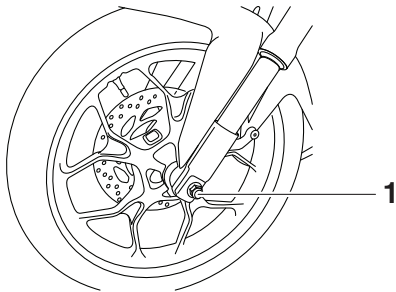

1. Axle nut

2. Lift the front wheel off the ground according to the procedure in the previous section "Supporting the motorcycle".

3. Remove the brake hose holder by removing the bolt.
4. Remove the brake caliper by removing the bolts.

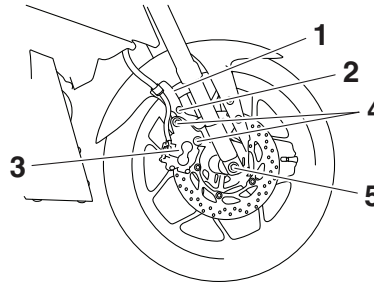

1. Brake hose holder
2. Bolt
3. Brake caliper
4. Brake caliper bolt
5. Wheel axle

5. Remove the front wheel axle nut.
6. Pull the wheel axle out, and then remove the wheel. **NOTICE: Do not apply the brake after the brake calipers have been removed, otherwise the brake pads will be forced shut.** [ECA11052]

### To install the front wheel

1. Lift the wheel up between the fork legs.
2. Insert the wheel axle and install the wheel axle nut.
3. Lower the front wheel so that it is on the ground.
4. Install the brake caliper by installing the bolts.

#### TIP

Make sure that there is enough space between the brake pads before installing the brake caliper onto the brake disc.

5. Install the brake hose holder by installing the bolt.
6. Tighten the wheel axle and brake caliper bolts to the specified torques.

#### Tightening torques:

- Wheel axle:  
40 N·m (4.0 kgf·m, 30 lb·ft)
- Brake caliper bolt:  
35 N·m (3.5 kgf·m, 25 lb·ft)

7. Push down hard on the handlebar several times to check for proper fork operation.

# Periodic maintenance and adjustment

## Rear wheel

EAU25081

EAU2180

EWA10822

### To remove the rear wheel



#### WARNING

To avoid injury, securely support the vehicle so there is no danger of it falling over.

1. Loosen the locknut and drive chain slack adjusting bolt on each side of the swingarm.
2. Loosen the axle nut.

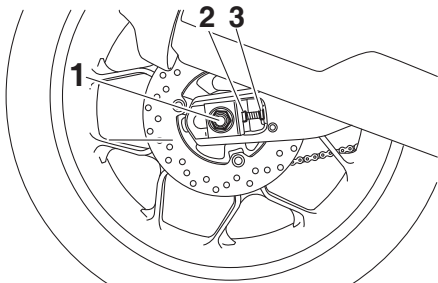

1. Axle nut
2. Drive chain slack adjusting bolt
3. Locknut

3. Raise the vehicle so the rear wheel is off the ground. (See page 7-32.)
4. Remove the axle nut.
5. Push the wheel forward, and then remove the drive chain from the rear sprocket.

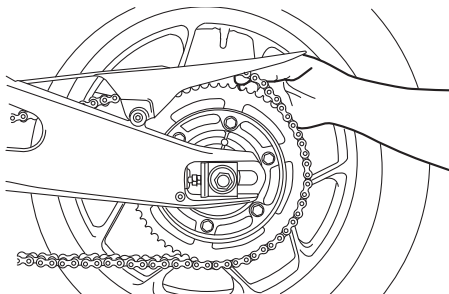

#### TIP

- If the drive chain is difficult to remove, remove the wheel axle first, and then lift the wheel upward enough to remove the drive chain from the rear sprocket.
  - The drive chain does not need to be disassembled in order to remove and install the rear wheel.
6. While supporting the brake caliper and slightly lifting the wheel, pull the wheel axle out.

#### TIP

A rubber mallet may be useful to tap the wheel axle out.

7. Remove the wheel. **NOTICE: Do not apply the brake after the wheel and brake disc have been removed, otherwise the brake pads will be forced shut.** [ECA11073]

### To install the rear wheel

1. Install the wheel and the brake caliper bracket by inserting the wheel axle from the right side.

#### TIP

- Make sure that the slot in the brake caliper bracket is fit over the retainer on the swingarm.
- Make sure that there is enough space between the brake pads before installing the wheel.

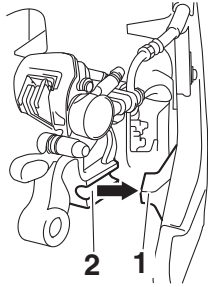

1. Retainer
2. Slot

2. Install the drive chain onto the rear sprocket.
3. Install the axle nut.
4. Lower the vehicle so the rear wheel is on the ground, and then put the sidestand down.
5. Adjust the drive chain slack. (See page 7-23.)

EAU25872

## Troubleshooting

Although Yamaha motorcycles receive a thorough inspection before shipment from the factory, trouble may occur during operation. Any problem in the fuel, compression, or ignition systems, for example, can cause poor starting and loss of power.

The following troubleshooting charts represent quick and easy procedures for checking these vital systems yourself. However, should your motorcycle require any repair, take it to a Yamaha dealer, whose skilled technicians have the necessary tools, experience, and know-how to service the motorcycle properly.

Use only genuine Yamaha replacement parts. Imitation parts may look like Yamaha parts, but they are often inferior, have a shorter service life and can lead to expensive repair bills.

EWA15142

## **WARNING**

**When checking the fuel system, do not smoke, and make sure there are no open flames or sparks in the area, including pilot lights from water**

**heaters or furnaces. Gasoline or gasoline vapors can ignite or explode, causing severe injury or property damage.**

---

# Periodic maintenance and adjustment

EAU86350

## Troubleshooting chart

### 1. Fuel

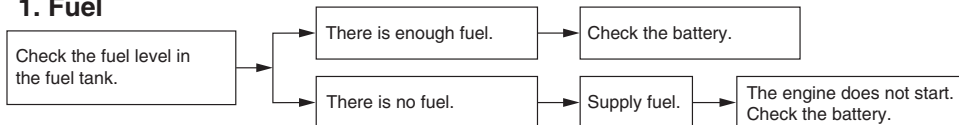

### 2. Battery

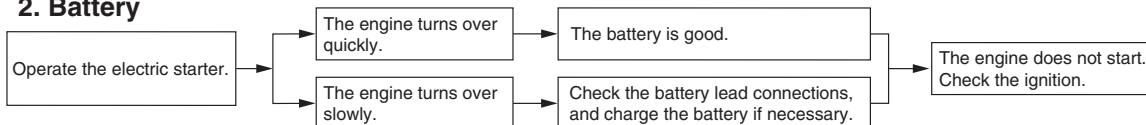

### 3. Ignition

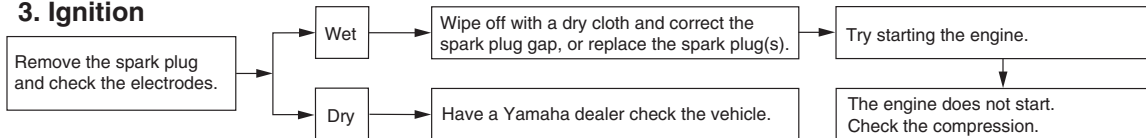

### 4. Compression

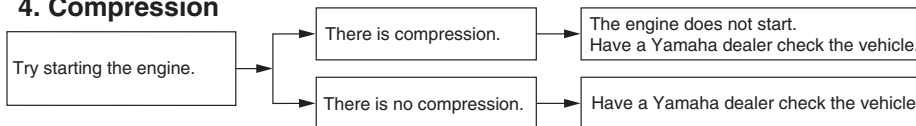

# Periodic maintenance and adjustment

EAU86420

## Engine overheating

EWAT1041

### WARNING

- Do not remove the radiator cap when the engine and radiator are hot. Scalding hot fluid and steam may be blown out under pressure, which could cause serious injury. Be sure to wait until the engine has cooled.
- Place a thick rag, like a towel, over the radiator cap, and then slowly rotate the cap counterclockwise to the detent to allow any residual pressure to escape. When the hissing sound has stopped, press down on the cap while turning it counterclockwise, and then remove the cap.

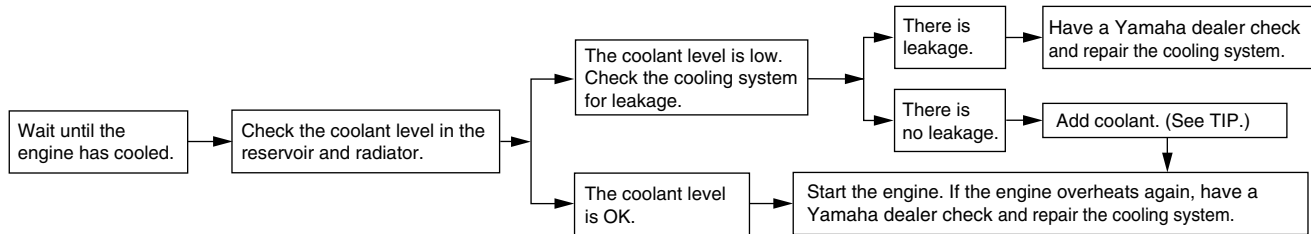

### TIP

If coolant is not available, tap water can be temporarily used instead, provided that it is changed to the recommended coolant as soon as possible.

# Motorcycle care and storage

---

## Matte color caution

EAU37834

EAU84990

### NOTICE

Some models are equipped with matte colored finished parts. Be sure to consult a Yamaha dealer for advice on what products to use before cleaning the vehicle. Using a brush, harsh chemical products or cleaning compounds when cleaning these parts will scratch or damage their surface. Wax also should not be applied to any matte colored finished parts.

---

ECA15193

## Care

Frequent, thorough cleaning of the vehicle will not only enhance its appearance but also will improve its general performance and extend the useful life of many components. Washing, cleaning, and polishing will also give you a chance to inspect the condition of the vehicle more frequently. Be sure to wash the vehicle after riding in the rain or near the sea, because salt is corrosive to metals.

### TIP

- Genuine Yamaha care and maintenance products are sold under the YAMALUBE brand in many markets worldwide.
  - See your Yamaha dealer for additional cleaning tips.
- 

ECA26280

### NOTICE

Improper cleaning can cause cosmetic and mechanical damage. Do not use:

- high-pressure washers or steam-jet cleaners. Excessive water pressure may cause wa-

ter seepage and deterioration of wheel bearings, brakes, transmission seals and electrical devices. Avoid high-pressure detergent applications such as those available in coin-operated car washers.

- harsh chemicals, including strong acidic wheel cleaners, especially on spoke or magnesium wheels.
  - harsh chemicals, abrasive cleaning compounds, or wax on matte-finished parts. Brushes can scratch and damage the matte-finish, use soft sponge or towel only.
  - towels, sponges, or brushes contaminated with abrasive cleaning products or strong chemicals such as, solvents, gasoline, rust removers, brake fluid, or antifreeze, etc.
- 

### Before washing

1. Park the vehicle out of direct sunlight and allow it to cool. This will help avoid water spots.



2. Make sure all caps, covers, electrical couplers and connectors are tightly installed.
3. Cover the muffler end with a plastic bag and a strong rubber band.
4. Pre-soak stubborn stains like insects or bird droppings with a wet towel for a few minutes.
5. Remove road grime and oil stains with a quality degreasing agent and a plastic-bristle brush or sponge. **NOTICE: Do not use degreasing agent on areas requiring lubrication such as seals, gaskets, and wheel axles. Follow product instructions.**

[ECA26290]

## Washing

1. Rinse off any degreaser and spray down the vehicle with a garden hose. Use only enough pressure to do the job. Avoid spraying water directly into the muffler, instrument panel, air inlet, or other inner areas such as underseat storage compartments.
2. Wash the vehicle with a quality automotive-type detergent mixed with cool water and a soft, clean towel or sponge. Use an old toothbrush or plastic-bristle brush for hard-to-reach places. **NOTICE: Use cold water if the vehicle has been exposed to salt. Warm water will increase salt's corrosive properties.** [ECA26301]
3. For windshield-equipped vehicles: Clean the windshield with a soft towel or sponge dampened with water and a pH neutral detergent. If necessary, use a high-quality windshield cleaner or polish for motorcycles. **NOTICE: Never use any strong chemicals to clean the windshield. Additionally, some cleaning compounds for plastic may scratch the windshield, so be sure to test all cleaning products before general application.** [ECA26310]
4. Rinse off thoroughly with clean water. Be sure to remove all detergent residues, as they can be harmful to plastic parts.

## After washing

1. Dry the vehicle with a chamois or absorbent towel, preferably microfiber terrycloth.
2. For drive chain-equipped models: Dry and then lubricate the drive chain to prevent rust.
3. Use a chrome polish to shine chrome, aluminum, and stainless steel parts. Often the thermally induced discoloring of stainless steel exhaust systems can be removed through polishing.
4. Apply a corrosion protection spray on all metal parts including chrome or nickel-plated surfaces. **WARNING! Do not apply silicone or oil spray to seats, hand grips, rubber foot pegs or tire treads. Otherwise these parts will become slippery, which could cause loss of control. Thoroughly clean the surfaces of these parts before operating the vehicle.** [EWA20650]
5. Treat rubber, vinyl, and unpainted plastic parts with a suitable care product.

# Motorcycle care and storage

6. Touch up minor paint damage caused by stones, etc.
7. Wax all painted surfaces using a non-abrasive wax or use a detail spray for motorcycles.
8. When finished cleaning, start the engine and let it idle for several minutes to help dry any remaining moisture.
9. If the headlight lens has fogged up, start the engine and turn on the headlight to help remove the moisture.
10. Let the vehicle dry completely before storing or covering it.

ECA26320

## NOTICE

8

- Do not apply wax to rubber or unpainted plastic parts.
- Do not use abrasive polishing compounds as they will wear away the paint.
- Apply sprays and wax sparingly. Wipe off excess afterwards.

EWA20660

## WARNING

Contaminants left on the brakes or tires can cause loss of control.

- **Make sure there is no lubricant or wax on the brakes or tires.**
- **If necessary, wash the tires with warm water and a mild detergent.**
- **If necessary, clean the brake discs and pads with brake cleaner or acetone.**
- **Before riding at higher speeds, test the vehicle's braking performance and cornering behavior.**

EAU83472

## Storage

Always store the vehicle in a cool, dry place. If necessary, protect it against dust with a porous cover. Be sure the engine and the exhaust system are cool before covering the vehicle. If the vehicle often sits for weeks at a time between uses, the use of a quality fuel stabilizer is recommended after each fill-up.

ECA21170

## NOTICE

- **Storing the vehicle in a poorly ventilated room or covering it with a tarp, while it is still wet, will allow water and humidity to seep in and cause rust.**
- **To prevent corrosion, avoid damp cellars, stables (because of the presence of ammonia) and areas where strong chemicals are stored.**

## Long term storage

Before storing the vehicle long term (60 days or more):

# Motorcycle care and storage

1. Make all necessary repairs and perform any outstanding maintenance.
2. Follow all instructions in the Care section of this chapter.
3. Fill up the fuel tank, adding fuel stabilizer according to product instructions. Run the engine for 5 minutes to distribute treated fuel through the fuel system.
4. For vehicles equipped with a fuel cock: Turn the fuel cock lever to the off position.
5. For vehicles with a carburetor: To prevent fuel deposits from building up, drain the fuel in the carburetor float chamber into a clean container. Retighten the drain bolt and pour the fuel back into the fuel tank.
6. Use a quality engine fogging oil according to product instructions to protect internal engine components from corrosion. If engine fogging oil is not available, perform the following steps for each cylinder:
  - a. Remove the spark plug cap and spark plug.
  - b. Pour a teaspoonful of engine oil into the spark plug bore.
  - c. Install the spark plug cap onto the spark plug, and then place the spark plug on the cylinder head so that the electrodes are grounded. (This will limit sparking during the next step.)
  - d. Turn the engine over several times with the starter. (This will coat the cylinder wall with oil.)  
**WARNING! To prevent damage or injury from sparking, make sure to ground the spark plug electrodes while turning the engine over.**  
[EWA10952]
  - e. Remove the spark plug cap from the spark plug, and then install the spark plug and the spark plug cap.
7. Lubricate all control cables, pivots, levers and pedals, as well as the sidestand and centerstand (if equipped).
8. Check and correct the tire air pressure, and then lift the vehicle so that all wheels are off the ground. Otherwise, turn the wheels a little once a month in order to prevent the tires from becoming degraded in one spot.
9. Cover the muffler outlet with a plastic bag to prevent moisture from entering it.
10. Remove the battery and fully charge it, or attach a maintenance charger to keep the battery optimally charged. **NOTICE: Confirm that the battery and its charger are compatible. Do not charge a VRLA battery with a conventional charger.** [ECA26330]

## TIP

- If the battery will be removed, charge it once a month and store it in a temperate location between 0-30 °C (32-90 °F).
- See page 7-29 for more information on charging and storing the battery.

# Specifications

## Dimensions:

- Overall length:  
2005 mm (78.9 in)
- Overall width:  
805 mm (31.7 in)
- Overall height:  
1080 mm (42.5 in)
- Seat height:  
810 mm (31.9 in)
- Wheelbase:  
1330 mm (52.4 in)
- Ground clearance:  
170 mm (6.69 in)
- Minimum turning radius:  
2.2 m (7.22 ft)

## Weight:

- Curb weight:  
134 kg (295 lb)

## Engine:

- Combustion cycle:  
4-stroke
- Cooling system:  
Liquid cooled
- Valve train:  
SOHC
- Number of cylinders:  
Single cylinder
- Displacement:  
155 cm<sup>3</sup>
- Bore × stroke:  
58.0 × 58.7 mm (2.28 × 2.31 in)
- Starting system:  
Electric starter

## Engine oil:

Recommended brand:



- SAE viscosity grades:  
10W-40
- Recommended engine oil grade:  
API service SG type or higher, JASO standard MA
- Engine oil quantity:  
Oil change:  
0.85 L (0.90 US qt, 0.75 Imp.qt)  
With oil filter removal:  
0.95 L (1.00 US qt, 0.84 Imp.qt)

## Coolant quantity:

- Coolant reservoir (up to the maximum level mark):  
0.15 L (0.16 US qt, 0.13 Imp.qt)
- Radiator (including all routes):  
0.49 L (0.52 US qt, 0.43 Imp.qt)

## Fuel:

- Recommended fuel:  
Unleaded gasoline (E10 acceptable)
- Octane number (RON):  
90
- Fuel tank capacity:  
10 L (2.6 US gal, 2.2 Imp.gal)
- Fuel reserve amount:  
1.8 L (0.48 US gal, 0.40 Imp.gal)

## Fuel injection:

- Throttle body:  
ID mark:  
B9B1 00

## Drivetrain:

- Gear ratio:  
1st:  
2.833 (34/12)
- 2nd:  
1.875 (30/16)
- 3rd:  
1.364 (30/22)
- 4th:  
1.143 (24/21)
- 5th:  
0.957 (22/23)
- 6th:  
0.840 (21/25)

## Front tire:

- Type:  
Tubeless
- Size:  
110/70-17 M/C 54S
- Manufacturer/model:  
IRC/TRAIL WINNER GP-211F

## Rear tire:

- Type:  
Tubeless
- Size:  
140/70-17 M/C 66S
- Manufacturer/model:  
IRC/TRAIL WINNER GP-211R

**Loading:**

Maximum load:

172 kg (379 lb)

(Total weight of rider, passenger, cargo and accessories)

Auxiliary light:

LED

License plate light:

5.0 W

**Front brake:**

Type:

Hydraulic single disc brake

**Rear brake:**

Type:

Hydraulic single disc brake

**Front suspension:**

Type:

Telescopic fork

**Rear suspension:**

Type:

Swingarm (link suspension)

**Electrical system:**

System voltage:

12 V

**Battery:**

Model:

YTZ4V

Voltage, capacity:

12 V, 3.0 Ah (10 HR)

**Bulb wattage:**

Headlight:

LED

Brake/tail light:

LED

Front turn signal light:

10.0 W

Rear turn signal light:

10.0 W

# Consumer information

## Identification numbers

Record the vehicle identification number and the engine serial number in the spaces provided below for assistance when ordering spare parts from a Yamaha dealer or for reference in case the vehicle is stolen.

VEHICLE IDENTIFICATION NUMBER:

ENGINE SERIAL NUMBER:

EAU26366

## Vehicle identification number

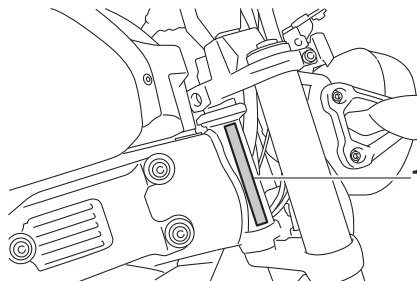

1. Vehicle identification number

The vehicle identification number is stamped into the steering head pipe. Record this number in the space provided.

### **TIP** \_\_\_\_\_

The vehicle identification number is used to identify your motorcycle and may be used to register your motorcycle with the licensing authority in your area.

---

EAU26401

## Engine serial number

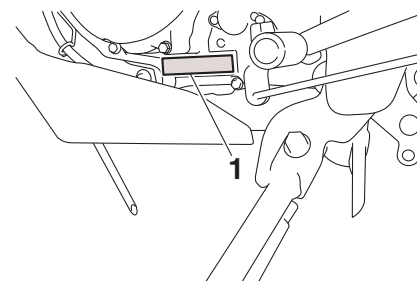

1. Engine serial number

The engine serial number is stamped on the bottom left side of the crankcase.

EAU1221

## Vehicle data recording

EAU85400

This model's ECU stores certain vehicle data to assist in the diagnosis of malfunctions and for research, statistical analysis and development purposes.

Although the sensors and recorded data will vary by model, the main data points are:

- Vehicle status and engine performance data
- Fuel-injection and emission-related data

This data will be uploaded only when a special Yamaha diagnostic tool is attached to the vehicle, such as when maintenance checks or service procedures are performed.

Yamaha will not disclose this data to a third party except in the following cases. In addition, Yamaha may provide vehicle data to a contractor in order to outsource services related to the handling of vehicle data. Even in this case, Yamaha will require the contractor to

properly handle the vehicle data we provided and Yamaha will appropriately manage the data.

- With the consent of the vehicle owner
- Where obligated by law
- For use by Yamaha in litigation
- When the data is not related to an individual vehicle nor owner

# Index

- A**  
Air filter element and check hose,  
cleaning ..... 7-14
- B**  
Battery ..... 7-29  
Brake and clutch levers,  
checking and lubricating ..... 7-27  
Brake and shift pedals,  
checking and lubricating ..... 7-26  
Brake fluid, changing ..... 7-23  
Brake fluid level, checking ..... 7-22  
Brake lever ..... 4-11  
Brake lever free play, checking ..... 7-20  
Brake light switches ..... 7-20  
Brake pedal ..... 4-11
- C**  
Cables, checking and lubricating ..... 7-25  
Canister ..... 7-10  
Care ..... 8-1  
Catalytic converter ..... 4-13  
Clock ..... 4-7  
Clutch lever ..... 4-10  
Clutch lever free play, adjusting ..... 7-19  
Coolant ..... 7-13  
Coolant temperature warning light ..... 4-3  
Cowlings, removing and installing ..... 7-8
- D**  
Data recording, vehicle ..... 10-2  
Dimmer/Pass switch ..... 4-9  
Drive chain, cleaning and lubricating ..... 7-25  
Drive chain slack ..... 7-23
- E**  
Engine break-in ..... 6-1  
Engine idling speed ..... 7-15  
Engine oil and oil filter element ..... 7-10  
Engine overheating ..... 7-37  
Engine serial number ..... 10-1  
Engine trouble warning light ..... 4-3
- F**  
Front and rear brake pads, checking ... 7-21  
Front fork, checking ..... 7-28  
Fuel ..... 4-12  
Fuel consumption, tips for reducing ..... 6-3  
Fuel meter ..... 4-5  
Fuel tank cap ..... 4-11  
Fuses, replacing ..... 7-31
- H**  
Handlebar switches ..... 4-9  
Helmet holder ..... 4-14  
Helmets ..... 2-6  
High beam indicator light ..... 4-3  
Horn switch ..... 4-9
- I**  
Identification numbers ..... 10-1  
Indicator lights and warning lights ..... 4-3
- K**  
Keyhole shutter ..... 4-2
- L**  
Labels, location ..... 1-1
- M**  
Main switch/steering lock ..... 4-1  
Maintenance and lubrication,  
periodic ..... 7-4  
Maintenance,  
emission control system ..... 7-2  
Matte color, caution ..... 8-1  
Multi-function display ..... 4-6  
Multi-function meter unit ..... 4-4
- N**  
Neutral indicator light ..... 4-3
- P**  
Parking ..... 6-4  
Part locations ..... 3-1
- S**  
Safe-riding points ..... 2-5  
Safety information ..... 2-1  
Seat ..... 4-14  
Shifting ..... 6-3  
Shift pedal ..... 4-10  
Sidestand ..... 4-15  
Sidestand, checking and lubricating ..... 7-27  
Spark plug, checking ..... 7-8  
Specifications ..... 9-1  
Speedometer ..... 4-4  
Start/Engine stop switch ..... 4-9  
Starting circuit cut-off system ..... 4-15  
Starting the engine ..... 6-2  
Steering, checking ..... 7-29  
Storage ..... 8-3  
Supporting the motorcycle ..... 7-32  
Swingarm pivots, lubricating ..... 7-28
- T**  
Tachometer ..... 4-4  
Throttle grip and cable,  
checking and lubricating ..... 7-26  
Throttle grip free play, adjusting ..... 7-16  
Tires ..... 7-17  
Tool kit ..... 7-1  
Transmission gear display ..... 4-5  
Troubleshooting ..... 7-35  
Troubleshooting chart ..... 7-36  
Turn signal indicator lights ..... 4-3



Turn signal light bulb, replacing ..... 7-32  
Turn signal switch..... 4-9

## **V**

Valve clearance ..... 7-16  
Vehicle identification number ..... 10-1  
Vehicle lights ..... 7-31  
VVA indicator..... 4-5

## **W**

Wheel bearings, checking ..... 7-29  
Wheel (front) ..... 7-33  
Wheel (rear)..... 7-34  
Wheels ..... 7-18

## **Y**

Yamalube..... 7-13



PRINTED IN THAILAND  
2019.07 (E)